



LABO GLASS
Laboratory Glassware
AN ISO 9001 : 2015

AN ISO 9001: 2015 Company.

SCIENTIFIC GLASS CREATIONS.



Laboratory Glassware & Equipment

Catalogue Cum INR Price List 2023





Certificate of Registration

This is to certify that

SCIENTIFIC GLASS CREATIONS

4/12/2 GANDHI NAGAR, AMBALA CANTT - 133001, HARYANA, INDIA

has been independently assessed by QRO
and is compliant with the requirement of:

ISO 9001:2015

Quality Management System

For the following scope of activities:

**MANUFACTURING AND EXPORTING OF LABORATORY GLASSWARE,
SCIENTIFIC EQUIPMENT AND EDUCATIONAL LABWARE**

Date of Certification: 28th April 2023

2nd Surveillance Audit Due: 27th April 2025

1st Surveillance Audit Due: 27th April 2024

Certificate Expiry: 27th April 2026

Certificate Number: 305023042816Q



Chauhan

Head of Certification

Validity of this certificate is subject to annual surveillance audits to be done successfully on or before 365 days from date of the audit.
(In case surveillance audit is not allowed to be conducted; this certificate shall be suspended / withdrawn).

The Validity of this certificate can be verified at www.qrocert.org

This certificate of registration remains the property of QRO Certification LLP, and shall be returned immediately upon request.

India Office : QRO Certification LLP

142, IInd Floor, Avtar Enclave, Near Paschim Vihar West Metro Station, Delhi-110063, (INDIA)

Website : www.qrocert.org E-mail : info@qrocert.org

TECHNICAL DATA

Low Expansion Borosilicate Glass

From the 16th century to, today, chemical research teams have used glass containers for a very basic reason the glass container is transparent, almost invisible. And so the contents and the reaction are clearly visible. But because always adequate for laboratory works. Laboratory works requires apparatus made in a glass, which can readily be moulded into any desired shape or form, which offers maximum inertness when in contact with the widest range of chemical substances, which can withstand thermal shock with fracture and high temperature work without deforming, and which will be resilient enough to survive the everyday knocks to which it will be subjected in normal laboratory handling, washing and sterilizing processes.

Chemical Composition

SGC Labs is a low alkali borosilicate composition. Its typical chemical composition is given under. It is virtually free of magnesia-lime-zinc group and contain only traces of heavy metals.

Percentage By Weight	
SiO ₂	81
B ₂ O ₃	13
Na ₂ O	4

In general the 'Strain point' should be regarded as the maximum safe operating temperature of SGC labs. When heated above 500° C the glass may acquire permanent stresses on cooling. All SGC Labs ware is annealed in modern ovens under strictly controlled conditions to ensure minimal residual stress in the products.

Chemical Durability

SGC Labs in highly resistance water, neutral and acid solutions, concentrated acids and their mixtures as well as to chloride, bromine, iodine, and organic matters. Even during extended period of reaction and at temperatures above 100° C, its chemical resistance exceeds tha of mot metals and other materials. It can withstand repeated dry and wet sterilisation without surface deterioration and subsequent contamination. Resistance to attack of various chemicals is shown under. Only hydrofloric acid, very hot phosphoric acid and alkaline solutions increasingly attack the glass surface with rising concentration and temperature.

TECHNICAL DATA

Contact Chemical	Duration in hour	Loss in Wt. mg/m
Water distilled at 100°C	6	10
Water Vapour Steam at 121°C	1	75
Acid HCl	6	100
80% H ₂ SO ₄ at 130°C	12	140
Alkali - 1N soln. of Na ₂ CO ₃ boiling Infusion Fluids Isotonic	6	4000
NaCl(0.85%) 121°C	2.5	70
Glucose(5%)121°C	2.5	50

Water And Acid Resistance

The impact of acids and water on the surface of borosilicate glass is insignificant. Only a very small amount of monovalent ions is released into the surrounding medium at the beginning of the impact. Non-porous layers of silica gel is created gradually on the glass surface. The layer works as an inhibitor against the further influence of the surrounding medium. Hydrofluoric acid and hot phosphoric acid are the only exceptions from the above described mechanisms of impact of water and acids on the glass surface. Both acids prevent the creation of silica gel layer on the glass surface.

Fabrication With Borosilicate Glassware

Due to low expansion of glass and easy work ability, this glass can be shaped, formed, joined into complicated apparatus. It can be done even by an analyst in his own laboratory. He can keep on changing till he gets what he needs. In case where annealing in a controlled oven is difficult he can do so by flame annealing which is also a great advantage.

Optical Properties

Laboratory Glassware made from Borosilicate Glass shows no noticeable absorption in the visible region of the spectrum. It appears consequently clear and colourless.



Foreword

Very humbly, we present herewith our latest 2022-23 Catalogue. **SGCLABS** blown Laboratory Glassware are fabricated from low alkali borosilicate type .3.3 glass, having chemical composition S_2O_2 : 81%, B_2O_3 : 13%, Na_2O / K_2O : 4% Al_2O_3 : 2% approx by weight.

The thermal properties of glass are coefficient of Linear expansion $32.5 \times 10^{-7} / OC$, strain point : $515^\circ C$, Annealing Point: $5650C$, Softening Point: $820^\circ C$, Specific Heat: 0.2 and thermal Conductivity ($Cal/cm^3 / ^\circ C/Sec$): 0.0027:

It has been specially mentioned in our catalogue where any other type of glass is used. Viz. Quartz, Silica, borosilicate Neutral or Soda Glass etc.

This Catalogue-cum-Price list covers a wide range of apparatus required for colleges, Universities, Industries, Research & Development Organizations. To give you clear indication of what's being offered we have tried the maximum of illustrations and figures.

We are in this line of mouth blown glassware for more than Two decades Our workshop is fully equipped with modern and latest plant, machinery equipment and experienced staff. Quality is controlled by our experts at every step of manufacturing to maintain accuracy and perfectness. We can really offer you high class mouth blown products, equivalent to that manufactured anywhere in developed countries.

Our's is an ISO-9001-2015 Certified Company

We are also registered with N.S.I.C New Delhi as a Small Scale Unit

We also undertake to manufacture new apparatus according to customers specifications. All enquires for research are dealt with promptly

While placing your valued order, please mention our catalogue numbers, minimum Qty/Pack along with a short description.

In the end, we sincerely thank all patrons and clients. old and new, for their indulgent co-operation in the past. We on our turn fully assure that all enquiries and valued orders will receive our best prompt attentions, as usual

Management
SCIENTIFIC GLASS CREATIONS

CONTENTS

S.No.	Descriptions	Page No.
1.	Volumetric /Graduated Glassware	1-13
2.	General Glassware(as Tubes, Beakers, Bottles, Flask etc.)	14-34
3.	Standard Joints Components	35-42
4.	Seprating /Dropping Funnles	42-45
5.	Assemblies, Extractors & Disstilations	45-51
6.	Sintered Glasswares	52-54
7.	Misc. Glassware(as Stopcocks, Clinical, Gas Analysis, Dairy App, Chromatography.)	54-65
8.	Silica Laboratory Ware	65
9.	Thermometer Hydrometer	66-69
10.	PTFE/ Plastic Labware	70-75
11.	Laboratory Metal Products	75-79
12.	Laboratory Rubber Products	79-82
13.	Laboratory Equipments	82-93
14.	Liquid Handling Equipments	93-95

BURETTES

01.100 Burettes "SGCLABS", with Straight Bore Glass Key Stopcock. Accuracy as per Class 'A' of ISO 587/ IS 1997 : 1982, with Calibration Certificate.

Sap Code	Cat No. (ml)	Capacity (ml)	Sub.Div. (ml)	Tolerance (±ml)	Price/Piece. INR
BU-GK-10-A	100/10	10	0.05	0.02	390.00
BU-GK-25-A	100/25	25	0.1	0.05	360.00
BU-GK-50-A	100/50	50	0.1	0.05	380.00
BU-GK-100-A	100/100	100	0.2	0.1	460.00

01.102 Burettes "SGCLABS", AMBER, with Straight Bore Glass Key Stopcock. Accuracy as per Class 'A' of ISO 587/ IS 1997 : 1982, with Calibration Certificate.

Sap Code	Cat No. (ml)	Capacity (ml)	Sub.Div. (ml)	Tolerance (±ml)	Price/Piece. INR
BUA-GK-10-A	102/10	10	0.05	0.02	530.00
BUA-GK-25-A	102/25	25	0.1	0.05	520.00
BUA-GK-50-A	102/50	50	0.1	0.05	585.00
BUA-GK-100-A	102/100	100	0.2	0.1	630.00

01.104 Burettes "SGCLABS", with Straight Bore Glass Key Stopcock. Accuracy as per Class 'B' of ISO 587/ IS 1997:1982.

Sap Code	Cat No. (ml)	Capacity (ml)	Sub.Div. (ml)	Tolerance (±ml)	Price/Piece. INR
BU-GK-10-B	104/10	10	0.05	0.05	200.00
BU-GK-25-B	104/25	25	0.1	0.1	150.00
BU-GK-50-B	104/50	50	0.1	0.1	165.00
BU-GK-100-B	104/100	100	0.2	0.2	225.00

01.106 Burettes "SGCLABS", with Screw Type PTFE Needle Valve Stopcock. Accuracy as per Class 'A' of ISO 587/ IS 1997 : 1982, with Calibration certificate.

Sap Code	Cat No. (ml)	Capacity (ml)	Sub.Div. (ml)	Tolerance (±ml)	Price/Piece. INR
BU-RF-10-A	106/10	10	0.05	0.02	390.00
BU-RF-25-A	106/25	25	0.1	0.05	360.00
BU-RF-50-A	106/50	50	0.1	0.05	380.00
BU-RF-100-A	106/100	100	0.2	0.1	460.00



01.100



01.102



01.104



01.106

01.108 Burettes "SGCLABS", AMBER with Screw Type PTFE Needle Valve Stopcock. Accuracy as per Class 'A' of ISO 587/ IS 1997 : 1982, with Calibration Certificate.

Sap Code	Cat No.	Capacity	Sub.Div.	Tolerance	Price/Piece.
	(ml)	(ml)	(ml)	(±ml)	INR
.BUA-RF-10-A	108/10	10	0.05	0.02	530.00
BUA-RF-25-A	108/25	25	0.1	0.05	520.00
BUA-RF-50-A	108/50	50	0.1	0.05	585.00
BUA-RF-100-A	108/100	100	0.2	0.1	630.00

01.110 Burettes "SGCLABS", with Screw Type PTFE Needle Valve Stopcock. Accuracy as per Class 'B' of ISO 587/ IS 1997 : 1982.

Sap Code	Cat No.	Capacity	Sub.Div.	Tolerance	Price/Piece.
	(ml)	(ml)	(ml)	(±ml)	INR
BU-RF-10-B	110/10	10	0.05	0.05	200.00
BU-RF-25-B	110/25	25	0.1	0.1	145.00
BU-RF-50-B	110/50	50	0.1	0.1	165.00
BU-RF-100-B	110/100	100	0.2	0.2	225.00

01.112 Burettes "SGCLABS", with Straight Bore PTFE key Stopcock. Accuracy as per Class 'A' of ISO 587/ IS 1997 : 1982 with Calibration Certificate.

Sap Code	Cat No.	Capacity	Sub.Div.	Tolerance	Price/Piece.
	(ml)	(ml)	(ml)	(±ml)	INR
BU-PTFE-10-A	112/10	10	0.05	0.02	590.00
BU-PTFE-10-A	112/25	25	0.1	0.05	540.00
BU-PTFE-10-A	112/50	50	0.1	0.05	565.00
BU-PTFE-10-A	112/100	100	0.2	0.1	625.00

01.114 Burettes "SGCLABS", AMBER with Straight Bore PTFE key Stopcock. Accuracy as per Class 'A' of ISO 587/ IS 1997 : 1982 with Calibration Certificate.

Sap Code	Cat No.	Capacity	Sub.Div.	Tolerance	Price/Piece.
	(ml)	(ml)	(ml)	(±ml)	INR
BUA-PTFE-10-A	114/10	10	0.05	0.02	750.00
BUA-PTFE-10-A	114/25	25	0.1	0.05	705.00
BUA-PTFE-10-A	114/50	50	0.1	0.05	770.00
BUA-PTFE-10-A	114/100	100	0.2	0.1	795.00

01.116 Burettes "SGCLABS", with Straight Bore PTFE key Stopcock. Accuracy as per Class 'B' of ISO 587/ IS 1997 : 1982

01.108



01.110



01.112



01.114

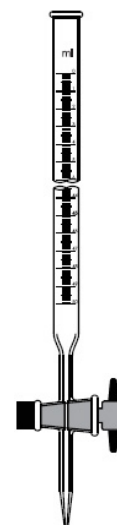

01.116

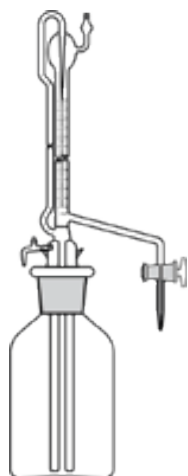

01.118

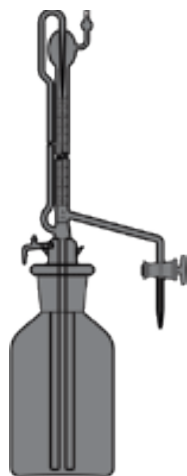

01.120

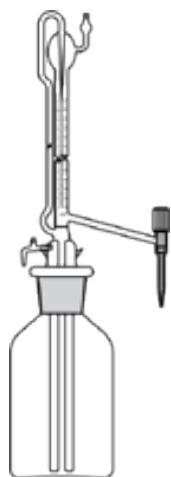

01.122

Sap Code	Cat No.	Capacity	Sub.Div.	Tolerance	Price/Piece.
	(ml)	(ml)	(ml)	(±ml)	INR
BU-PTFE-10-B	116/10	10	0.05	0.02	435.00
BU-PTFE-25-B	116/25	25	0.1	0.05	380.00
BU-PTFE-50-B	116/50	50	0.1	0.05	405.00
BU-PTFE-100-B	116/100	100	0.2	0.1	475.00

01.118 Burettes "SGCLABS", Automatic Zero, with Glass Key Stopcock, mounted on Reservoir, Rubber bellow, Accuracy as per Class `A' of IS 1997 : 1982, with Calibration Certificate.

Sap Code	Cat No.	Capacity	Sub.Div.	Tolerance	Price/Piece.
	(ml)	(ml)	(ml)	(±ml)	INR
ABU-GK-10-A	118/10	10	0.05	0.02	2100.00
ABU-GK-10-A	118/25	25	0.1	0.05	2900.00
ABU-GK-10-A	118/50	50	0.1	0.05	3100.00
ABU-GK-10-A	118/100	100	0.2	0.1	3200.00

Note : Reservoir Capacity for 10ml burettes is 500ml and for 25, 50 & 100ml burettes is 2000ml.

01.120 Burettes "SGCLABS", AMBER, Automatic Zero, with Glass Key Stopcock, mounted on Reservoir, Rubber bellow, Accuracy as per Class `A' of IS 1997 : 1982, with Calibration Certificate.

Sap Code	Cat No.	Capacity	Sub.Div.	Tolerance	Price/Piece.
	(ml)	(ml)	(ml)	(±ml)	INR
ABUA-GK-10-A	120/10	10	0.05	0.02	2875.00
ABUA-GK-10-A	120/25	25	0.1	0.05	3750.00
ABUA-GK-10-A	120/50	50	0.1	0.05	3900.00
ABUA-GK-10-A	120/100	100	0.2	0.1	4100.00

Note : Reservoir Capacity for 10ml burettes is 500ml and for 25, 50 & 100ml burettes is 2000ml.

01.122 Burettes "SGCLABS", Automatic Zero, with Screw type PTFE Needle Valve Stopcock, mounted on Reservoir, Rubber bellow, Accuracy as per Class `A' of IS 1997:1982, with calibration certificate.

Sap Code	Cat No.	Capacity	Sub.Div.	Tolerance	Price/Piece.
	(ml)	(ml)	(ml)	(±ml)	INR
ABU-RF-10-A	122/10	10	0.05	0.02	2100.00
ABU-RF-10-A	122/25	25	0.1	0.05	2900.00
ABU-RF-10-A	122/50	50	0.1	0.05	3100.00
ABU-RF-10-A	122/100	100	0.2	0.1	3200.00

Note : Reservoir Cap. for 10ml burettes is 500ml & for 25, 50 & 100ml burettes is 2000ml.

01.124 Burettes "SGCLABS", AMBER, Automatic Zero, with Screw type PTFE Needle Valve Stopcock, mounted on Reservoir, Rubber bellow, Accuracy as per Class `A' of IS 1997 : 1982, with calibration certificate.

Sap Code (ml)(ml)	Cat No. (ml)	Capacity (±ml)	Sub.Div. INR	Tolerance	Price/Piece.
ABUA-RF-10-A	124/10	10	0.05	0.02	2875.00
ABUA-RF-25-A	124/25	25	0.1	0.05	3750.00
ABUA-RF-50-A	124/50	50	0.1	0.05	3900.00
ABUA-RF-100-A	124/100	100	0.2	0.1	4100.00

Note : Reservoir Cap. for 10ml burettes is 500ml & for 25, 50 & 100ml burettes is 2000ml.

01.126 Burettes "SGCLABS", Automatic Zero, with PTFE Key Stopcock, mounted on Reservoir, Rubber bellow, Accuracy as per Class `A' of IS 1997 : 1982, with calibration certificate.

Sap Code	Cat No. (ml)	Capacity (ml)	Sub.Div. (ml)	Tolerance (±ml)	Price/Piece. INR
ABU-PTFE-10-A	126/10	10	0.05	0.05	2400.00
ABU-PTFE-25-A	126/25	25	0.1	0.1	3200.00
ABU-PTFE-50-A	126/50	50	0.1	0.1	3350.00
ABU-PTFE-100-A	126/100	100	0.2	0.2	3450.00

Note : Reservoir Cap. for 10ml burettes is 500ml & for 25, 50 & 100ml burettes is 2000ml.

01.128 Burettes "SGCLABS", AMBER, Automatic Zero, with PTFE Key Stopcock, mounted on Reservoir, Rubber bellow, Accuracy as per Class `A' of IS 1997 : 1982, with calibration certificate.

Sap Code	Cat No. (ml)	Capacity (ml)	Sub.Div. (ml)	Tolerance (±ml)	Price/Piece. INR
ABUA-PTFE-10-A	128/10	10	0.05	0.05	3100.00
ABUA-PTFE-25-A	128/25	25	0.1	0.1	4100.00
ABUA-PTFE-50-A	128/50	50	0.1	0.1	4200.00
ABUA-PTFE-100-A	128/100	100	0.2	0.2	4350.00

Note : Reservoir Cap. for 10ml burettes is 500ml & for 25, 50 & 100ml burettes is 2000ml.

01.130 Burettes "SGCLABS", with Pinch Cock Rubber tubing and glass jet. Accuracy as per Class `B' of ISO 587/ IS 1997:1982.

Sap Code	Cat No. (ml)	Capacity (ml)	Sub.Div. (ml)	Tolerance (±ml)	Price/Piece. INR
BU-PC-10	130/10	10	0.05	0.05	82.00
BU-PC-10	130/10	25	0.1	0.1	72.00
BU-PC-10	130/10	50	0.1	0.1	85.00

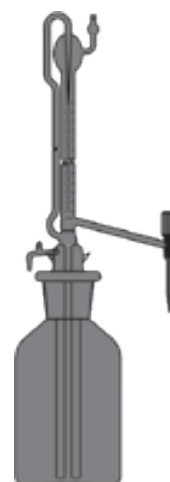

01.124

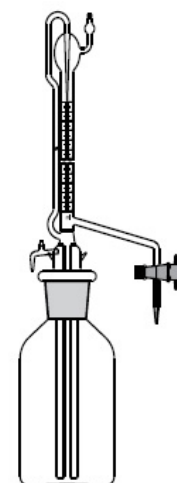

01.033

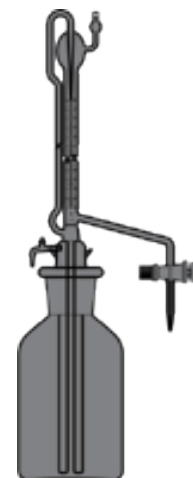

01.128



01.130

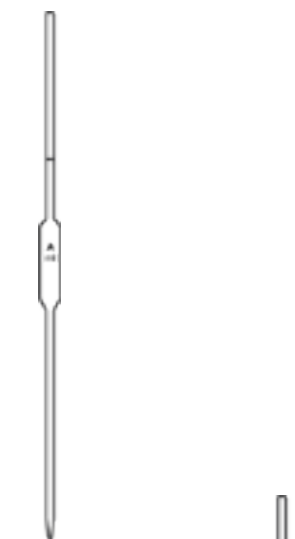

01.132



01.134

PIPETTE

01.132 Pipettes Transfer, Volumetric, "SGCLABS", one mark, Accuracy as per Class `A' of ISO 648/ IS 1117 : 1975, with calibration certificate.

Sap Code	Cat No.	Capacity (ML)	Tolerance (±ML)	Price/Piece. INR
PT-V-1-A	132/1	1	0.006	90.00
PT-V-2-A	132/2	2	0.01	90.00
PT-V-5-A	132/5	5	0.015	90.00
PT-V-10-A	132/10	10	0.02	90.00
PT-V-20-A	132/20	20	0.03	115.00
PT-V-25-A	132/25	25	0.03	115.00
PT-V-50-A	132/50	50	0.05	150.00
PT-V-100-A	132/100	100	0.08	225.00

01.134 Pipettes Transfer, Volumetric, "SGCLABS", one mark. Accuracy as per Class `B' of ISO 648/ IS 1117 : 1975.

Sap Code	Cat No.	Capacity (ML)	Tolerance (±ML)	Price/Piece. INR
PT-V-1-B	134/1	1	0.015	54.00
PT-V-2-B	134/2	2	0.02	55.00
PT-V-5-B	134/5	5	0.03	45.00
PT-V-10-B	134/10	10	0.04	60.00
PT-V-120B	134/20	20	0.06	70.00
PT-V-1-25	134/25	25	0.06	71.00
PT-V-1-50	134/50	50	0.1	105.00
PT-V-1-100	134/100	100	1.16	148.00

01.136 Pipettes, Measuring, Graduated, Serological, "SGCLABS", . Accuracy as per Class `A' with calibration certificate. Color coded. (These pipettes are calibrated to deliver from any graduation line down to zero at the jet, with the last drop expelled by blowing). These pipettes are graduated to tip (machine made) and deliver their total capacity when last drop is blown out.

Sap Code	Cat No.	Capacity (ml)	Sub.Div. (ml)	Tolerance (±ml)	Price/Piece. INR
PT-S-0.1-A	136/0.1	0.1	0.01	0.006	105.00
PT-S-0.2-A	136/0.2	0.2	0.01	0.006	105.00
PT-S-0.5-A	136/0.5	0.5	0.02	0.006	105.00
PT-S-1-A	136/1	1	0.01	0.006	105.00
PT-S-1-A	136/1	1	0.1	0.006	105.00
PT-S-2-A	136/2	2	0.02	0.01	105.00
PT-S-2-A	136/2	2	0.1	0.01	105.00
PT-S-5-A	136/5	5	0.05	0.03	105.00
PT-S-5-A	136/5	5	0.1	0.05	105.00
PT-S-10-A	136/10	10	0.1	0.05	105.00
PT-S-25-A	136/25	25	0.2	0.1	140.00

01.138 Pipettes, Measuring, Graduated, Serological, "SGCLABS", Accuracy as per Class `B' of ISO 835 Color coded. (These pipettes are calibrated to deliver from any graduation line down to zero at the jet, with the last drop expelled by blowing). These pipettes are graduated to tip (machine made) and deliver their total capacity when last drop is blown out.

Sap Code	Cat No.	Capacity (ml)	Sub.Div. (ml)	Tolerance (±ml)	Price/Piece. INR
PT-S-0.1-B	138/0.1	0.1	0.01	0.01	51.00
PT-S-0.2-B	138/0.2	0.2	0.01	0.01	51.00
PT-S-0.5-B	138/0.5	0.5	0.02	0.01	51.00
PT-S-1-B	138/1	1	0.01	0.01	51.00
PT-S-1-B	138/1	1	0.1	0.01	51.00
PT-S-2-B	138/2	2	0.02	0.02	54.00
PT-S-2-B	138/2	2	0.1	0.02	55.00
PT-S-5-B	138/5	5	0.05	0.05	50.00
PT-S-5-B	138/5	5	0.1	0.1	51.00
PT-S-10-B	138/10	10	0.1	0.1	51.00
PT-S-25-B	138/25	25	0.2	0.2	82.00

01.140 Pipettes, Measuring, Graduated, Mohr type, "SGCLABS", Accuracy as per Class `A' of ISO 835 / IS 4162:1985 with calibration certificate. Color coded. (These pipettes are graduated for the delivery from zero mark at top to the last graduation mark.) Pipette tips are machine made.

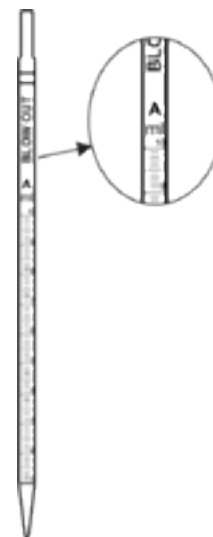

01.136



01.138



01.140



01.142

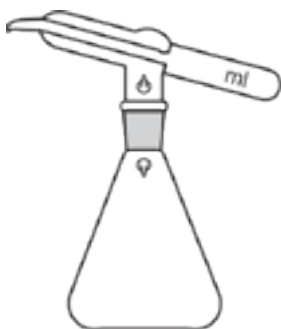

01.144

Sap Code	Cat No.	Capacity (ml)	Sub.Div. (ml)	Tolerance (±ml)	Price/Piece. INR
PT-M-0.1-A	140/0.1	0.1	0.01	0.006	105.00
PT-M-0.2-A	140/0.2	0.2	0.01	0.006	105.00
PT-M-0.5-A	140/0.5	0.5	0.02	0.006	105.00
PT-M-1-A	140/1	1	0.01	0.006	105.00
PT-M-1-A	140/1	1	0.1	0.006	105.00
PT-M-2-A	140/2	2	0.02	0.01	105.00
PT-M-2-A	140/2	2	0.1	0.01	105.00
PT-M-5-A	140/5	5	0.05	0.03	105.00
PT-M-5-A	140/5	5	0.1	0.05	105.00
PT-M-10-A	140/10	10	0.1	0.05	105.00
PT-M-25-A	140/25	25	0.2	0.1	140.00

01.142 Pipettes, Measuring, Graduated, Mohr type, "SGCLABS", Accuracy as per Class `B' of ISO 835 / IS 4162:1985. Color coded. (These pipettes are graduated for delivery from zero mark at top to the last graduation mark.) Pipette tips are machine made.

Sap Code	Cat No.	Capacity (ml)	Sub.Div. (ml)	Tolerance (±ml)	Price/Piece. INR
PT-M-0.1-B	142/0.1	0.1	0.01	0.01	51.00
PT-M-0.2-B	142/0.2	0.2	0.01	0.01	51.00
PT-M-0.5-B	142/0.5	0.5	0.02	0.01	51.00
PT-M-1-B	142/1	1	0.01	0.01	51.00
PT-M-1-B	142/1	1	0.1	0.01	51.00
PT-M-2-B	142/2	2	0.02	0.02	54.00
PT-M-2-B	142/2	2	0.1	0.02	55.00
PT-M-5-B	142/5	5	0.05	0.05	50.00
PT-M-5-B	142/5	5	0.1	0.1	51.00
PT-M-10-B	142/10	10	0.1	0.1	51.00
PT-M-25-B	142/25	25	0.2	0.2	82.00

01.144 Pipettes Automatic "SGCLABS", Quick acting for rapid work of approximate accuracy (Tilt Measure) complete with Conical Flask, interchangeable joint fitting.

Sap Code	Cat No.	Capacity (ml)	Reservoir Capacity (ml)	Price/Piece. INR
PTA-TM-1	144/1	1	100	325.00
PTA-TM-2	144/2	2	100	325.00
PTA-TM-5	144/5	5	250	350.00
PTA-TM-10	144/10	10	250	350.00
PTA-TM-20	144/20	20	500	405.00
PTA-TM-25	144/25	25	500	405.00

01.146 Pipette for Milk Test "SGCLABS", Bacteriological, Graduated as per IS Specifications No. 2025 : 1962.

Sap Code	Cat No.	Capacity (ml)	Sub.Div. (ml)	Tolerance (\pm ml)	Price/Piece. INR
PT-MT-1.1	146/1.1	1.1	0.5, 1 & 1.1	0.025	76.00
PT-MT-2.2	146/2.2	2.2	1.0, 2.0, 2.1 & 2.2	0.04	81.00

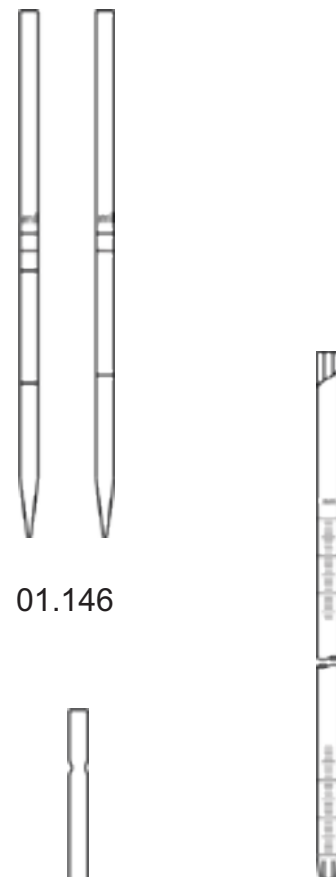
01.148 Pipette E.S.R. "SGCLABS", 200 mm. graduation, 300 mm long
INR35.00

01.146

01.148

01.150

01.150 Pipette, Pasteur, Disposable, Neutral Borosilicate Glass.

Sap Code	Cat No.	Length approx. (mm)	Minimum Qty. (pcs)	Price/Piece. INR
PT-PD-205	150/205	Length 205 Mm.	100	360.00
PT-PD-230	150/230	Length 230 Mm.	100	425.00

VOLUMETRIC FLASK

01.152 Flask Volumetric "SGCLABS", with interchangeable glass stopper, accuracy as per Class 'A' of ISO 1042/ IS 915 : 2006, with calibration certificate.

Sap Code	Cat No.	Capacity (ml)	Tolerance (\pm ml)	Stopper (Size)	Price/Piece. INR
VF-1-A152/1	*1	0.01	10/19	78.00	
VF-2-A	152/2	*2	0.015	10/19	78.00
VF-5-A	152/5	5	0.025	10/19	99.00
VF-10-A	152/10	10	0.025	10/19	102.00
VF-20-A	152/20	20	0.04	10/19	110.00
VF-25-A	152/25	25	0.04	10/19	110.00
VF-50-A	152/50	50	0.06	10/19	144.00
VF-100-A	152/100	100	0.1	14/23	180.00
VF-200-A	152/200	200	0.15	14/23	230.00
VF-250A	152/250	250	0.15	14/23	230.00
VF-500-A	152/500	500	0.25	19/26	398.00
VF-1000-A	152/1000	1000	0.4	19/26	600.00
VF-2000-A	152/2000	2000	0.6	24/29	1250.00
VF-5000-A	152/5000	5000	1.2	34/35	4800.00

* 1 ml. and 2 ml. Volumetric Flasks are of Test Tube shape. Note : Above Volumetric Flasks can also be supplied with Plastic Stoppers on request.



01.152



01.154

01.154 Flask Volumetric, "SGCLABS", AMBER, with interchangeable glass stopper, accuracy as per Class 'A' of ISO 1042/ IS 915 : 2006, with calibration certificate.

Sap Code	Cat No.	Capacity (ml)	Tolerance (±ml)	Stopper (Size)	Price/Piece. INR
VFA-1-A	154/1	*1	0.01	10/19	110.00
VFA-2-A	154/2	*2	0.015	10/19	110.00
VFA-5-A	154/5	5	0.025	10/19	125.00
VFA-10-A	154/10	10	0.025	10/19	136.00
VFA-20-A	154/20	20	0.04	10/19	154.00
VFA-25-A	154/25	25	0.04	10/19	154.00
VFA-50-A	154/50	50	0.06	10/19	190.00
VFA-100-A	154/100	100	0.1	14/23	230.00
VFA-200-A	154/200	200	0.15	14/23	315.00
VFA-250-A	154/250	250	0.15	14/23	315.00
VFA-500-A	154/500	500	0.25	19/26	525.00
VFA-1000-A	154/1000	1000	0.4	19/26	790.00
VFA-2000-A	154/2000	2000	0.6	24/29	1570.00
VFA-5000-A	154/5000	5000	1.2	34/35	6500.00

* 1ml and 2ml Volumetric Flasks are of Test Tube shape. Note: Above Volumetric Flasks can also be supplied with Plastic Stoppers on request.

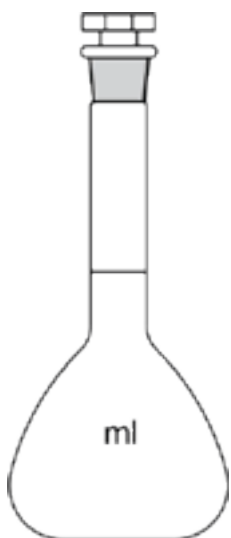

01.156

01.156 Flask Volumetric "SGCLABS", with interchangeable stopper, accuracy as per class 'B' of IS 915 : 2006.

Sap Code	Cat No.	Capacity (ml)	Tolerance (±ml)	Stopper (Size)	Price/Piece. INR
VF-1-B156/1	*1	0.03	10/19	48.00	
VF-2-B	156/2	*2	0.03	10/19	48.00
VF-5-B	156/5	5	0.05	10/19	57.00
VF-10-B	156/10	10	0.05	10/19	59.00
VF-20-B	156/20	20	0.05	10/19	69.00
VF-25-B	156/25	25	0.08	10/19	69.00
VF-50-B	156/50	50	0.12	10/19	86.00
VF-100-B	156/100	100	0.2	14/23	110.00
VF-200-B	156/200	200	0.3	14/23	150.00
VF-250-B	156/250	250	0.3	14/23	150.00
VF-500-B	156/500	500	0.5	19/26	250.00
VF-1000-B	156/1000	1000	0.8	19/26	430.00
VF-2000-B	156/2000	2000	1.2	24/29	890.00
VF-5000-B	156/5000	5000	2.5	34/35	4200.00

* 1 ml. and 2 ml. Volumetric Flasks are of Test Tube shape. Note : Above Volumetric Flasks can also be supplied with Plastic Stoppers on request..

01.158 Flasks Volumetric "SGCLABS", Sugar estimation with two marks without stopper.

Sap Code	Cat No.	Capacity (ml)	Price/ INR Piece.
VF-S-55	158/55	marked at 50ml. and 55ml.	115.00
VF-S-110	158/110	- do - 100ml. and 110ml.	150.00
VF-S-220	158/220	- do - 200ml. and 220ml.	190.00

01.160 Kohlraush Flasks (Mud Flask) "SGCLABS", with cup at top.

Sap Code	Cat No.	Capacity(ml)	Tolerance (\pm ml)	Price/Piece.
KF-50160/50	50	0.04		135.00
KF-100	160/100	100	0.06	160.00
KF-200	160/200	200	0.1	220.00

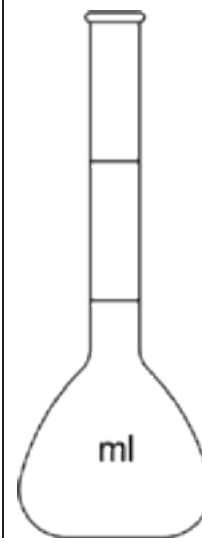

01.158

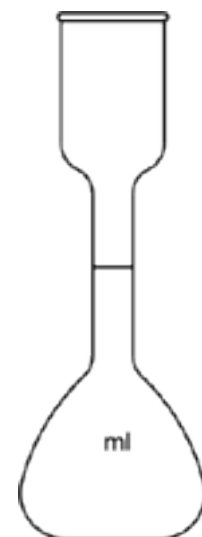

01.160

MEASURING CYLINDERS

01.162 Measuring Cylinders, "SGCLABS", with spout, Detachable Plastic Base.

Sap Code	Cat No.	Capacity (ml)	Sub. Div. (\pm ml)	Tolerance (\pm ml)	Price/Piece. INR
MC-PB-10	162/10	10	0.2	0.2	60.00
MC-PB-25	162/25	25	0.5	0.5	66.00
MC-PB-50	162/50	50	1	1	75.00
MC-PB-100	162/100	100	1	1	90.00
MC-PB-250	162/250	250	2	2	140.00



01.162

01.164 Measuring Cylinders, "SGCLABS", with spout, Hexagonal Base, Class 'A' with calibration certificate.

Sap Code	Cat No.	Capacity (ml)	Sub. Div. (\pm ml)	Tolerance (\pm ml)	Price/Piece. INR
MC-HB-5-A	164/5	5	0.1	0.05	202.00
MC-HB-10-A	164/5	10	0.2	0.1	210.00
MC-HB-25-A	164/5	25	0.5	0.25	240.00
MC-HB-50-A	164/5	50	1	0.5	310.00
MC-HB-100-A	164/5	100	1	0.5	370.00
MC-HB-250-A	164/5	250	2	1	560.00
MC-HB-500-A	164/5	500	5	2.5	810.00
MC-HB-1000-A	164/5	1000	10	5	995.00
MC-HB-2000-A	164/5	2000	20	10	1620.00



01.164



01.166

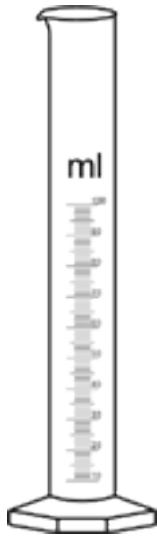

01.168



01.170

01.166 Measuring Cylinders, "SGCLABS", AMBER, with spout, Hexagonal Base, Class 'A' with calibration certificate.

Sap Code	Cat No.	Capacity (ml)	Sub. Div. (\pm ml)	Tolerance (\pm ml)	Price/Piece. INR
MCA-HB-5-A	166/5	5	0.1	0.05	260.00
MCA-HB-10-A	166/10	10	0.2	0.1	270.00
MCA-HB-25-A	166/25	25	0.5	0.25	300.00
MCA-HB-50-A	166/50	50	1	0.5	380.00
MCA-HB-100-A	166/100	100	1	0.5	440.00
MCA-HB-250-A	166/250	250	2	1	680.00
MCA-HB-500-A	166/500	500	5	2.5	998.00
MCA-HB-1000-A	166/1000	1000	10	5	1370.00
MCA-HB-2000-A	166/2000	2000	20	10	2150.00

01.168 Measuring Cylinders, "SGCLABS", with spout, Hexagonal Base, accuracy as per ISO 4788/ IS 878:1975

Sap Code	Cat No.	Capacity (ml)	Sub. Div. (\pm ml)	Tolerance (\pm ml)	Price/Piece. INR
MC-HB-5-B	168/5	5	0.1	0.1	135.00
MC-HB-10-B	168/10	10	0.2	0.2	140.00
MC-HB-25-B	168/25	25	0.5	0.5	165.00
MC-HB-50-B	168/50	50	1	1	180.00
MC-HB-100-B	168/100	100	1	1	210.00
MC-HB-250-B	168/250	250	2	2	360.00
MC-HB-500-B	168/500	500	5	5	495.00
MC-HB-1000-B	168/1000	1000	10	10	742.00
MC-HB-2000-B	168/2000	2000	20	20	1440.00

01.170 Measuring Cylinders, "SGCLABS", with interchangeable stopper, Hexagonal Base, Class 'A' with calibration certificate.

Sap Code	Cat No.	Capacity (ml)	Sub. Div. (\pm ml)	Tolerance (\pm ml)	Price/Piece. INR
MC-HBS-5-A	170/5	5	0.1	0.05	275.00
MC-HBS-10-A	170/10	10	0.2	0.1	284.00
MC-HBS-25-A	170/25	25	0.5	0.25	315.00
MC-HBS-50-A	170/50	50	1	0.5	418.00
MC-HBS-100-A	170/100	100	1	0.5	495.00
MC-HBS-250-A	170/250	250	2	1	784.00
MC-HBS-500-A	170/500	500	5	2.5	1260.00
MC-HBS-1000-A	170/1000	1000	10	5	1530.00
MC-HBS-2000-A	170/2000	2000	20	10	2340.00

01.172 Measuring Cylinders, "SGCLABS" AMBER, with interchangeable stopper Hexagonal Base, Class 'A' with calibration certificate.

Sap Code	Cat No.	Capacity (ml)	Sub. Div. (±ml)	Tolerance (±ml)	Price/Piece. INR
MCA-HBS-5-A	172/5	5	0.1	0.05	342.00
MCA-HBS-10-A	172/10	10	0.2	0.1	351.00
MCA-HBS-25-A	172/25	25	0.5	0.25	373.00
MCA-HBS-50-A	172/50	50	1	0.5	486.00
MCA-HBS-100-A	172/100	100	1	0.5	585.00
MCA-HBS-250-A	172/250	250	2	1	895.00
MCA-HBS-500-A	172/500	500	5	2.5	1400.00
MCA-HBS-1000-A	172/1000	1000	10	5	1935.00
MCA-HBS-2000-A	172/2000	2000	20	20	2925.00



01.172

01.174 Measuring Cylinders, "SGCLABS", with interchangeable stopper, Hexagonal Base, accuracy as per ISO 4788/ IS 878:1975.

Sap Code	Cat No.	Capacity (ml)	Sub. Div. (±ml)	Tolerance (±ml)	Price/Piece. INR
MC-HBS-5-B	174/5	5	0.1	0.1	194.00
MC-HBS-10-B	174/10	10	0.2	0.2	202.00
MC-HBS-25-B	174/25	25	0.5	0.5	210.00
MC-HBS-50-B	174/50	50	1	1	260.00
MC-HBS-100-B	174/100	100	1	1	310.00
MC-HBS-250-B	174/250	250	2	2	520.00
MC-HBS-500-B	174/500	500	5	5	738.00
MC-HBS-1000-B	174/1000	1000	10	10	1100.00
MC-HBS-2000-B	174/2000	2000	20	20	1790.00



01.174

01.176 Measuring Cylinders, "SGCLABS", with spout, Round Base, Class 'A', with calibration certificate.

Sap Code	Cat No.	Capacity (ml)	Sub. Div. (±ml)	Tolerance (±ml)	Price/Piece. INR
MC-RB-5-A	176/5	5	0.1	0.05	108.00
MC-RB-10-A	176/10	10	0.2	0.1	108.00
MC-RB-25-A	176/25	25	0.5	0.25	144.00
MC-RB-50-A	176/50	50	1	0.5	198.00
MC-RB-100-A	176/100	100	1	0.5	242.00
MC-RB-250-A	176/250	250	2	1	436.00
MC-RB-500-A	176/500	500	5	2.5	792.00
MC-RB-1000-A	176/1000	1000	10	5	880.00
MC-RB-2000-A	176/2000	2000	20	10	1395.00

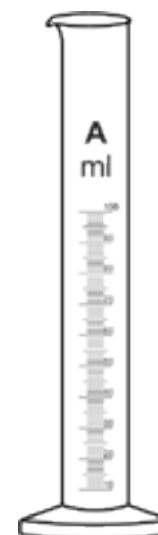

01.176



01.178

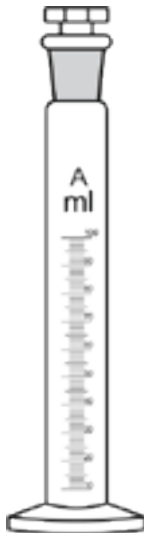

01.180



01.182



01.184

01.178 Measuring Cylinders, "SGCLABS", with spout, Round Base, accuracy as per ISO 4788/ IS 878:1975.

Sap Code	Cat No.	Capacity (ml)	Sub. Div. (\pm ml)	Tolerance (\pm ml)	Price/Piece. INR
MC-RB-5-B	178/5	5	0.1	0.1	70.00
MC-RB-10-B	178/10	10	0.2	0.2	70.00
MC-RB-25-B	178/25	25	0.5	0.5	96.00
MC-RB-50-B	178/50	50	1	1	126.00
MC-RB-100-B	178/100	100	1	1	152.00
MC-RB-250-B	178/250	250	2	2	260.00
MC-RB-500-B	178/500	500	5	5	440.00
MC-RB-1000-B	178/1000	1000	10	10	700.00
MC-RB-2000-B	178/2000	2000	20	20	1175.00

01.180 Measuring Cylinders, "SGCLABS", with interchangeable stopper, Round Base, Class `A' with Calibration Certificate.

Sap Code	Cat No.	Capacity (ml)	Sub. Div. (\pm ml)	Tolerance (\pm ml)	Price/Piece. INR
MC-RBS-5-A	180/5	5	0.1	0.1	150.00
MC-RBS-10-A	180/10	10	0.2	0.2	150.00
MC-RBS-25-A	180/25	25	0.5	0.5	205.00
MC-RBS-50-A	180/50	50	1	1	255.00
MC-RBS-100-A	180/100	100	1	1	310.00
MC-RBS-250-A	180/250	250	2	2	510.00
MC-RBS-500-A	180/500	500	5	5	1000.00
MC-RBS-1000-A	180/1000	1000	10	10	1175.00
MC-RBS-2000-A	180/2000	2000	20	20	1650.00

01.182 Measuring Cylinders, "SGCLABS", with interchangeable stopper, Round Base, accuracy as per ISO 4788/ IS 878:1975.

Sap Code	Cat No.	Capacity (ml)	Sub. Div. (\pm ml)	Tolerance (\pm ml)	Price/Piece. INR
MC-RBS-5-B	182/5	5	0.1	0.1	100.00
MC-RBS-10-B	182/10	10	0.2	0.2	100.00
MC-RBS-25-B	182/25	25	0.5	0.5	144.00
MC-RBS-50-B	182/50	50	1	1	180.00
MC-RBS-100-B	182/100	100	1	1	230.00
MC-RBS-250-B	182/250	250	2	2	380.00
MC-RBS-500-B	182/500	500	5	5	610.00
MC-RBS-1000-B	182/1000	1000	10	10	855.00
MC-RBS-2000-B	182/2000	2000	20	20	1500.00

01.184 Nessler Cylinder, "SGCLABS", for colour comparison graduated as per IS 4161 : 1967.

Sap Code	Cat No.	Capacity (ml)	Sub. Div. (\pm ml)	Price/Piece. INR
NC-50184/50	50	25 & 50	60.00	
NC-100	184/100	100	50 & 100	85.00

TUBES

02.186 Tubes, Culture, Media, "SGCLABS", Round Bottom, with Screw Cap, PTFE & Rubber liner.

Sap Code	Cat No.	Capacity (ml)	O.D.x Length mm (approx)	Price/Piece. INR
TC-RB-5	186/5	5	16 X 75	24.00
TC-RB-7.5	186/7.5	7.5	16 X 100	25.00
TC-RB-10	186/10	10	16 X 125	27.00
TC-RB-15	186/15	15	16 X 150	30.00
TC-RB-25	186/25	25	18X 150	34.00
TC-RB-30	186/30	30	25 X 100	35.00
TC-RB-45	186/45	45	25 X 150	39.00
TC-RB-60	186/60	60	25 X 200	42.00

02.188 Tubes, Culture, Media, "SGCLABS", Round Bottom, with Screw Cap & Rubber liner.

Sap Code	Cat No.	Capacity (ml)	O.D.x Length mm (approx)	Price/Piece. INR
TC-RBS-5	188/5	5	16 X 75	17.20
TC-RBS-7.5	188/7.5	7.5	16 X 100	17.70
TC-RBS-10	188/10	10	16 X 125	20.00
TC-RBS-15	188/15	15	16 X 150	22.00
TC-RBS-25	188/25	25	18X 150	26.00
TC-RBS-30	188/30	30	25 X 100	27.50
TC-RBS-45	188/45	45	25 X 150	30.00
TC-RBS-60	188/60	60	25 X 200	33.50

02.190 Tubes, Culture, Media, "SGCLABS", Flat Bottom, with Screw Cap and PTFE & Rubber liner.

Sap Code	Cat No.	Capacity (ml)	O.D.x Length mm (approx)	Price/Piece. INR
TC-FBSP-5	190/5	5	16 X 50	22.00
TC-FBSP-15	190/15	15	25 X 57	29.70
TC-FBSP-30	190/30	30	25 X 95	35.00

02.192 Tubes, Culture, Media, "SGCLABS", Flat Bottom, with Screw Cap and Rubber liner.

Sap Code	Cat No.	Capacity (ml)	O.D.x Length mm (approx)	Price/Piece. INR
TC-FBS-5	192/5	5	16 X 50	17.20
TC-FBS-15	192/15	15	25 X 57	20.50
TC-FBS-30	192/30	30	25 X 95	28.00



02.186



02.188



02.190



02.192

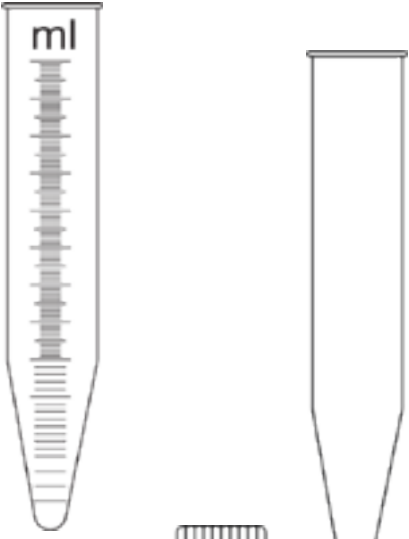

02.194

02.196

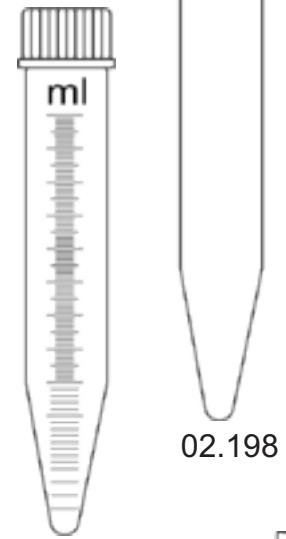

02.198

02.200

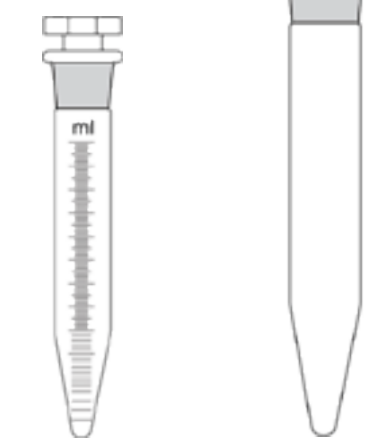

02.202

02.204

02.194 Centrifuge Tube, "SGCLABS", Conical bottom, graduated.

Sap Code	Cat No.	Capacity (ml)	O.D.x Length mm (approx)	Price/Piece. INR
CT-CBG-10	194/10	10	120x17	30.00
CT-CBG-15	194/15	15	120x17	36.00
CT-CBG-50	194/50	50	125x28	96.00

02.196 Centrifuge Tube, "SGCLABS", Conical bottom, plain.

Sap Code	Cat No.	Capacity (ml)	O.D.x Length mm (approx)	Price/Piece. INR
CT-CBP-10	196/10	10	110x15	19.50
CT-CBP-12	196/12	12	110x16	19.50
CT-CBP-15	196/15	15	120x17	19.50
CT-CBP-50	196/50	50	125x28	85.00

02.198 Centrifuge Tube, "SGCLABS", with Screw Cap, Plain.

Sap Code	Cat No.	Capacity (ml)	Price/Piece. \$	Price/Piece. INR.
CT-SP-10	198/10	10	1.08	54.00
CT-SP-15	198/15	15	1.12	56.00
CT-SP-50	198/50	50	2.40	120.00

02.200 Centrifuge Tube, "SGCLABS", with Screw Cap, Graduated

Sap Code	Cat No.	Capacity (ml)	Price/Piece. INR.
CT-SG-10	200/10	10	68.00
CT-SG-15	200/15	15	74.00
CT-SG-50	200/50	50	140.00

02.202 Centrifuge Tube, "SGCLABS", Conical bottom, Graduated, with interchangeable stopper.

Sap Code	Cat No.	Capacity (ml)	Price/Piece. INR
CT-CBGS-10	202/10	10	74.00
CT-CBGS-15	202/15	15	82.00
CT-CBGS-50	202/50	50	182.00

02.204 Centrifuge Tube, "SGCLABS", Plain, with interchangeable stopper, conical bottom.

Sap Code	Cat No.	Capacity (ml)	Price/Piece. INR
CT-CBPS-10	204/10	10	67.00
CT-CBPS-15	204/15	15	68.00
CT-CBPS-50	204/50	50	155.00

02.206 Test Tubes, "SGCLABS", Graduated, with interchangeable stopper.

Sap Code	Cat No.	O.D.x Length (mm)	Capacity (ml)	Sub Div.	Stopper Size	Price/Piece. INR
					TT-GS-5	206/5
100x12	5	0.1	10/19	72.00		
TT-GS-10	206/10	125x18	10	0.1	14/23	81.00
TT-GS-25	206/25	150x22	25	0.5	19/26	96.00
TT-GS-50	206/50	200x25	50	1	19/26	125.00
TT-GS-100	206/100	200x32	100	2	24/29	157.00

02.208 Test Tubes, "SGCLABS", with Interchangeable Stopper.

Sap Code	Cat No.	Height x O.D. (MM)	Socket Size	Price/Piece. INR
TT-S-10012	208/10012	100x12	10/19	51.00
TT-S-10012	208/12518	125x18	12/21	62.00
TT-S-15018	208/15018	150x18	14/23	70.00
TT-S-15022	208/15022	150x22	19/26	87.00
TT-S-15025	208/15025	150x25	19/26	90.00
TT-S-20025	208/20025	200x25	19/26	99.00
TT-S-20032	208/20032	200x32	24/29	140.00

02.210 Test Tubes, "SGCLABS", Boro 33 exp. glass, Round bottom, with rim, Plain.

Sap Code	Cat No.	Capacity (ml approx)	O.D.x Length (mm Approx)	Minimum Qty/Pack	Price/Piece. INR
TT-WR-1075	210/1075	3	10x75	100	4.20
TT-WR-1275	210/1275	5	12x75	100	4.75
TT-WR-12100	210/12100	8	12x100	100	5.90
TT-WR-15125	210/15125	10	15x125	100	8.00
TT-WR-15150	210/15150	15	15x150	100	9.50
TT-WR-18150	210/18150	25	18x150	100	10.40
TT-WR-25100	210/25100	35	25x100	50	14.25
TT-WR-25150	210/50150	50	25x150	50	16.00
TT-WR-25200	210/25200	75	25x200	50	21.00
TT-WR-32200	210/32200	100	32x200	25	40.00

02.212 Test Tubes, "SGCLABS", Boro 33exp. glass, Round bottom, rimless, Plain.

02.206



02.208



02.210



02.212



02.214



02.216



02.218

Sap Code	Cat No.	Capacity (ml approx)	O.D.x Length (mm Approx)	Minimum Qty/Pack	Price/Piece. INR
TT-RB-3	212/3	3	10x75	100	4.20
TT-RB-5	212/5	5	12x75	100	4.75
TT-RB-8	212/8	8	12x100	100	5.90
TT-RB-10	212/10	10	15x125	100	8.00
TT-RB-15	212/15	15	15x150	100	9.50
TT-RB-25	212/25	25	18x150	100	10.40
TT-RB-35	212/35	35	25x100	50	14.25
TT-RB-50	212/50	50	25x150	50	16.00
TT-RB-75	212/75	75	25x200	50	21.00
TT-RB-100	212/100	100	32x200	25	40.00

02.214 Test Tubes, "SGCLABS", Boro 33exp. glass, Round bottom, with rim, Graduated.

Sap Code	Cat No.	Capacity (ml approx)	O.D.x Length (mm Approx)	Minimum Qty/Pack	Price/Piece. INR
TT-WR-G-3	214/3	3	10x75	100	10.00
TT-WR-G-5	214/5	5	12x75	100	18.00
TT-WR-G-8	214/8	8	12x100	100	15.75
TT-WR-G-10	214/10	10	15x125	100	20.00
TT-WR-G-15	214/15	15	18x150	100	23.50
TT-WR-G-25	214/25	25	25x150	100	37.00
TT-WR-G-35	214/35	35	25x200	50	50.00

02.216 Test Tubes, "SGCLABS", Round bottom, with rim, made from Neutral Hard Glass, Heat resistant, Autoclaveable.

Sap Code	Cat No.	O.D.x Length (mm Approx)	W.T. (mm Approx)	Minimum Qty/Pack	Price/Piece. INR
TT-WR-NG-10	216/10	10x75	0.9	100	230.00
TT-WR-NG-12	216/12	12x75	0.9	100	255.00
TT-WR-NG-12	216/12	12x100	0.9	100	275.00
TT-WR-NG-15	216/15	15x100	0.9	100	325.00
TT-WR-NG-15	216/15	15x125	0.9	100	400.00
TT-WR-NG-15	216/15	15x150	0.9	100	500.00
TT-WR-NG-18	216/18	18x150	0.9	100	600.00
TT-WR-NG-25	216/25	25x150	1	50	840.00
TT-WR-NG-25	216/25	25x200	1	50	930.00

02.218 Test Tubes, "SGCLABS", Round bottom, without rim, made from Neutral Hard Glass, Heat resistant, Autoclaveable.

Sap Code	Cat No.	O.D.x Length (mm Approx)	W.T. (mm Approx)	Minimum Qty/Pack	Price/Piece. INR.
TT-NG-75	218/75	10x75	0.9	100	230.00
TT-NG-75	218/75	12x75	0.9	100	255.00
TT-NG-100	218/100	12x100	0.9	100	275.00
TT-NG-125	218/125	15x125	0.9	100	325.00
TT-NG-150	218/150	15x150	0.9	100	400.00
TT-NG-150	218/150	18x150	0.9	100	500.00
TT-NG-100	218/100	25x100	0.9	100	600.00
TT-NG-150	218/150	25x150	1	50	840.00
TT-NG-200	218/200	25x200	1	50	930.00

02.220 Tubes, Kjeldahl Digestion, "SGCLABS", with constriction on top.

Sap Code	Cat No.	O.D.x Length (ml)	Price/Piece. INR.
TK-D-24250	220/24250	24 X 250	115.00
TK-D-26250	220/26250	26 X 250	125.00
TK-D-40300	220/40300	40 X 300	225.00

02.222 Blood Sugar Tubes, "SGCLABS", Folin Wu, as per ISO/IS 3740:1966, Capacity 25 ml, marked at 4, 12.5 and 25 ml. 44.00

02.224 Wintrobe Tubes, "SGCLABS", 100 mm. Graduated. 21.00

02.226 Durham Tube, "SGCLABS",

Sap Code	Cat No.	Size mm	Qty/Pack	Price/Piece.
DT-25	226/25	25X6	100	2.70
DT-37	226/37	37X6	100	3.10
DT-50	226/50	50X6	100	3.80

02.228 Co-Agulation Tube (Melting Point Capillary) Length 100 mm, 100/vial 65.00

BEAKERS

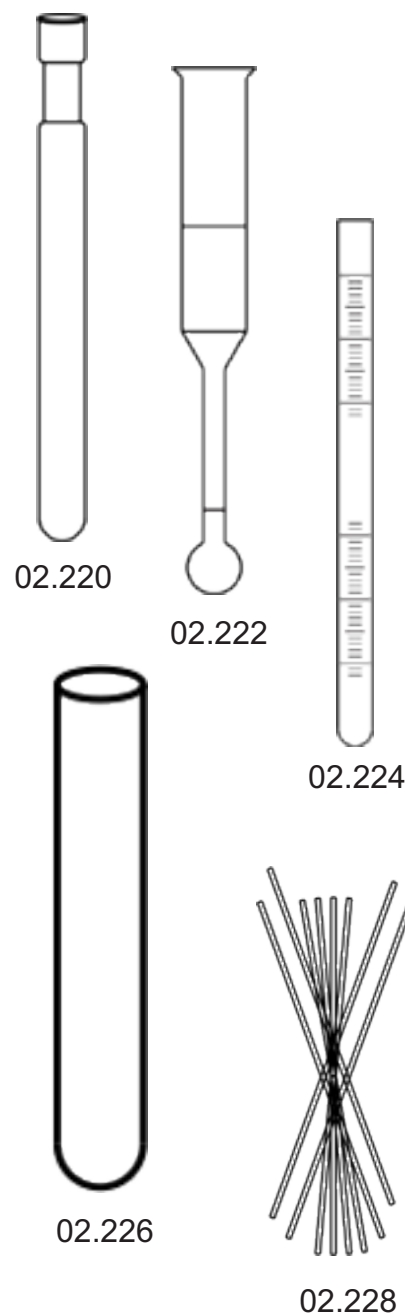
02.230 Beakers Low form, "SGCLABS", with spout, graduation \pm 5% accuracy.

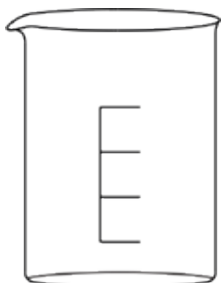

02.230

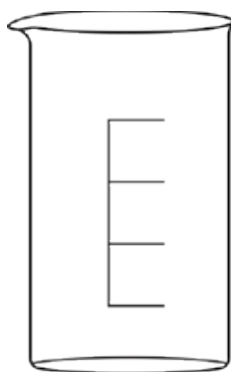

02.232

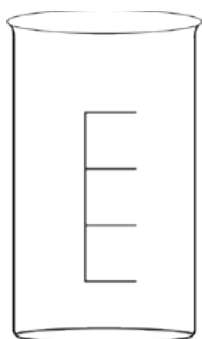

02.234

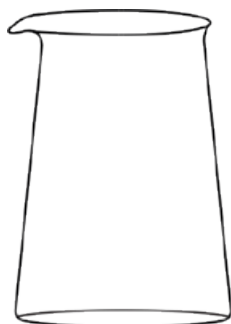

02.236

Sap Code	Cat No.	Capacity (ml)	Price/Piece. INR
BE-LF-5	230/5	5	36.00
BE-LF-10	230/10	10	40.00
BE-LF-25	230/25	25	42.00
BE-LF-50	230/50	50	36.00
BE-LF-100	230/100	100	40.00
BE-LF-150	230/150	150	45.00
BE-LF-250	230/250	250	53.50
BE-LF-400	230/400	400	84.00
BE-LF-500	230/500	500	89.00
BE-LF-600	230/600	600	93.00
BE-LF-800	230/800	800	130.00
BE-LF-1000	230/1000	1000	176.00
BE-LF-2000	230/2000	2000	325.00
BE-LF-3000	230/3000	3000	800.00
BE-LF-5000	230/5000	5000	1150.00

02.232 Beakers Tall form, "SGCLABS", with spout, graduation $\pm 5\%$ accuracy.

Sap Code	Cat No.	Capacity (ml)	Price/Piece. INR
BE-TF-S-50	232/50	50	55.00
BE-TF-S-100	232/100	100	60.00
BE-TF-S-150	232/150	150	62.00
BE-TF-S-250	232/250	250	68.00
BE-TF-S-500	232/500	500	108.00
BE-TF-S-1000	232/1000	1000	230.00

02.234 Beakers Tall form, "SGCLABS", without spout, graduation $\pm 5\%$ accuracy.

Sap Code	Cat No.	Capacity (ml)	Price/Piece. INR
BE-TF-50	234/50	50	55.00
BE-TF-100	234/100	100	60.00
BE-TF-150	234/150	150	62.00
BE-TF-250	234/250	250	68.00
BE-TF-500	234/500	500	108.00
BE-TF-1000	234/1000	1000	230.00

02.236 Beakers, Conical Shape, "SGCLABS", (Phillips Pattern) with spout.

Sap Code	Cat No.	Capacity (ml)	Price/Piece. INR
BE-CF-250	236/250	250	398.00
BE-CF-500	236/500	500	495.00

BOTTLES

02.238 Reagent Bottles, "SGCLABS", Narrow Mouth, with interchangeable Stopper.

Sap Code (ml)	Cat No.	Capacity (ml)	Stopper Size	Price/Piece. INR.
RB-NM-S-25	238/25	25/30	14/23	95.00
RB-NM-S-50	238/50	50/60	14/23	126.00
RB-NM-S-100	238/100	100/125	19/26	165.00
RB-NM-S-250	238/250	250	19/26	218.00
RB-NM-S-500	238/500	500	24/29	265.00
RB-NM-S-1000	238/1000	1000	29/32	380.00
RB-NM-S-2000	238/2000	2000	34/35	665.00
RB-NM-S-3000	238/3000	3000	45/40	1680.00
RB-NM-S-5000	238/5000	5000	45/40	5100.00

02.240 Reagent Bottles, "SGCLABS", AMBER, Narrow Mouth, with interchangeable Stopper.

Sap Code	Cat No.	Capacity (ml)	Stopper Size	Price/Piece. INR.
RBA-NM-S-25	240/25	25/30	14/23	175.00
RBA-NM-S-50	240/50	50/60	14/23	250.00
RBA-NM-S-125	240/125	100/125	19/26	280.00
RBA-NM-S-250	240/250	250	19/26	335.00
RBA-NM-S-500	240/500	500	24/29	420.00
RBA-NM-S-1000	240/1000	1000	29/32	550.00
RBA-NM-S-2000	240/2000	2000	34/35	965.00
RBA-NM-S-3000	240/3000	3000	45/40	5200.00
RBA-NM-S-5000	240/5000	5000	45/40	6700.00

02.242 Reagent Bottle "SGCLABS", Clear, wide mouth with Polypropylene Blue screw cap and pouring ring, repeatedly autoclavable, Graduated.

Sap Code	Cat No.	Capacity (ml)	Din Thread	Price/Piece. INR.
RB-WM-25	242/25	25	GL25	140.00
RB-WM-50	242/50	50	GL32	157.00
RB-WM-100	242/100	100	GL45	207.00
RB-WM-250	242/250	250	GL45	215.00
RB-WM-500	242/500	500	GL45	265.00
RB-WM-1000	242/1000	1000	GL45	405.00
RB-WM-2000	242/2000	2000	GL45	650.00
RB-WM-3000	242/3000	3000	GL45	1775.00
RB-WM-5000	242/5000	5000	GL45	3400.00
RB-WM-10000	242/10000	10000	GL45	5200.00
RB-WM-20000	242/20000	20000	GL45	8550.00

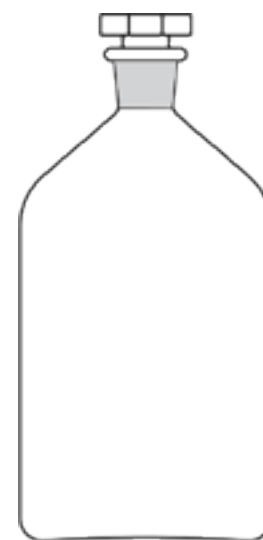

02.238



02.240

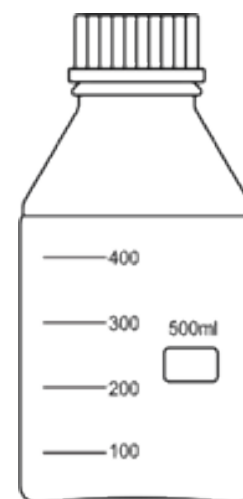

02.242

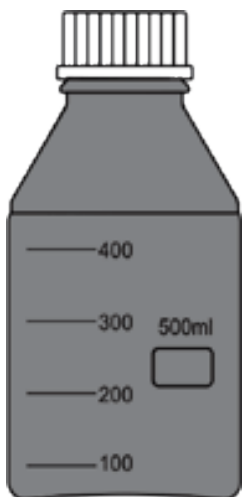

02.244

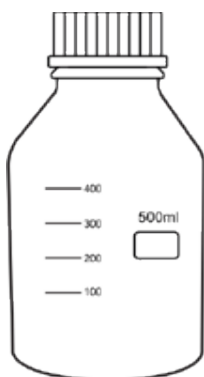

02.246



02.248

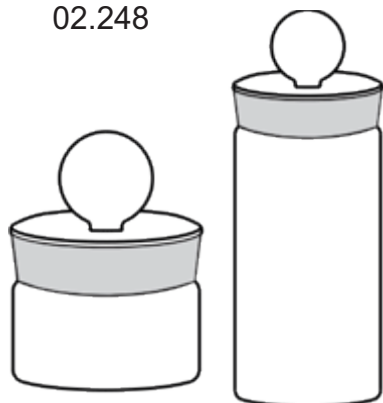

02.250

02.252

02.244 Reagent Bottle "SGCLABS", AMBER, wide mouth with Polypropylene Blue screw cap and without pouring ring, repeatedly autoclavable, graduated.

Sap Code	Cat No.	Capacity (ml)	DIN Thread	Price/Piece. INR.
RBA-WM-25	244/25	25	GL25	220.00
RBA-WM-50	244/50	50	GL32	245.00
RBA-WM-100	244/100	100	GL45	325.00
RBA-WM-250	244/250	250	GL45	360.00
RBA-WM-500	244/500	500	GL45	420.00
RBA-WM-1000	244/1000	1000	GL45	560.00
RBA-WM-2000	244/2000	2000	GL45	995.00
RBA-WM-3000	244/3000	3000	GL45	2615.00
RBA-WM-5000	244/5000	5000	GL45	5550.00
RBA-WM-10000	244/10000	10000	GL45	7500.00
RBA-WM-20000	244/20000	20000	GL45	11950.00

02.246 Reagent Bottle "SGCLABS", Clear, extra wide mouth with Polypropylene Blue screw cap and with pouring ring, repeatedly autoclavable, Graduated.

Sap Code	Cat No.	Capacity (ml)	Din Thread	Price/Piece. INR.
RB-EWM-5000	246/5000	5000	GL80	4040.00
RB-EWM-10000	246/10000	10000	GL80	6325.00
RB-EWM-20000	246/20000	20000	GL80	13200.00

02.248 Reagent Bottle "SGCLABS", AMBER, extra wide mouth with Polypropylene Blue screw cap & pouring ring, repeatedly autoclavable, Graduated.

Sap Code	Cat No.	Capacity (ml)	Din Thread	Price/Piece. INR.
RBA-EWM-5000	248/5000	5000	GL80	6045.00
RBA-EWM-10000	248/10000	10000	GL80	8550.00
RBA-EWM-20000	248/20000	20000	GL80	16750.00

02.250 Weighing Bottles, "SGCLABS", with interchangeable stopper.

Sap Code	Cat No.		O.D.x ht. (mm Approx)	Capacity (ml)	Price/Piece. INR.
WB-SF-4030	250/4030	Squat Form	40 X 30	20	135.00
WB-SF-5025	250/5025		50 X 25	20	195.00
WB-SF-5035	250/5035		50 X 35	35	205.00
WB-SF-5050	250/5050		50 X 50	50	215.00
WB-SF-6040	250/6040		60 X 40	40	260.00
WB-SF-2040	252/2040	Tall Form	20 X 40	5	75.00
WB-SF-2560	252/2560		25 X 60	15	85.00
WB-SF-3065	252/3065		30 X 65	25	112.00
WB-SF-4090	252/4090		40 X 90	60	154.00

02.254 Specific Gravity Bottles, "SGCLABS", Ground interchangeable PTFE stopper, certified capacity with Calibration Certificate.

Sap Code	Cat No.	Capacity(ml)	Tolerance (\pm MI)	Price/Piece.
SGB-PS-10	254/10	10	1	180.00
SGB-PS-25	254/25	25	2	185.00
SGB-PS-50	254/50	50	3	220.00

02.256 Specific Gravity Bottles, "SGCLABS", Ground in capillary stopper.

Sap Code	Cat No.	Capacity (ml)	Price/Piece.
SGB-CS-10	256/10	10	51.00
SGB-CS-20	256/25	25	52.00
SGB-CS-50	256/50	50	63.00

02.258 Dropping Bottles, "SGCLABS", fitted with interchangeable stopper and rubber teat.

Sap Code	Cat No.	Capacity (ml)	Price/Piece.
DB-S-25	258/25	25/30	130.00
DB-S-50	258/50	50/60	140.00
DB-S-125	258/125	100/125	180.00
DB-S-250	258/250	250	275.00

02.260 Bottles Aspirator, "SGCLABS", with interchangeable stopper, Glass key stopcock with interchangeable joint.

Sap Code	Cat No.	Capacity (ml)	Price/Piece.
BA-GK-1000	260/1000	1000	1480.00
BA-GK-2000	260/2000	2000	1740.00
BA-GK-3000	260/3000	3000	2580.00
BA-GK-5000	260/5000	5000	5320.00
BA-GK-10000	260/10000	10000	6900.00
BA-GK-20000	260/20000	20000	10200.00

02.262 Bottles Aspirator, "SGCLABS", with Outlet for Tubing.

Sap Code	Cat No.	Capacity (ml)	Price/Piece.
BA-OT-250	262/250	250	195.00
BA-OT-500	262/500	500	218.00
BA-OT-1000	262/1000	1000	375.00
BA-OT-2000	262/2000	2000	660.00

02.264 Woulf Bottles, "SGCLABS", with two standard joint necks.

Sap Code	Cat No.	Capacity (ml)	Price/Piece.
WB-2N-250	264/250	250	358.00
WB-2N-500	264/500	500	395.00
WB-2N-1000	264/1000	1000	640.00

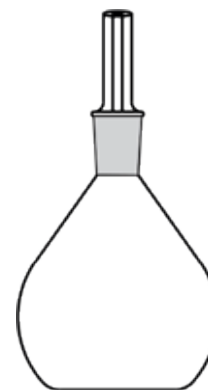

02.254

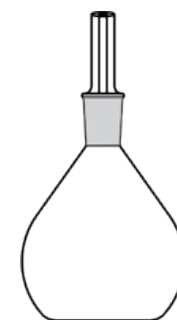

02.256

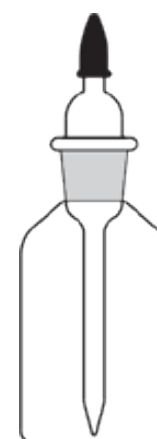

02.258

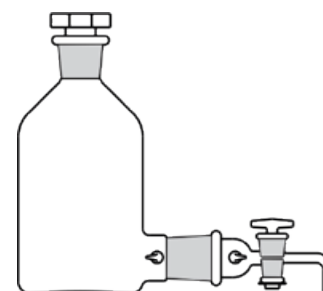

02.260

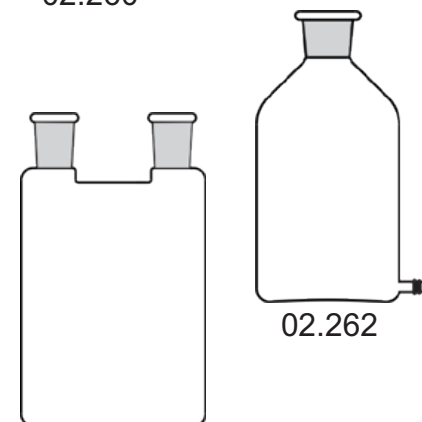

02.262

02.264

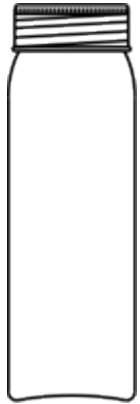

02.266

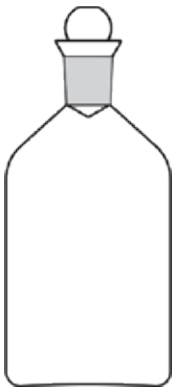

02.268

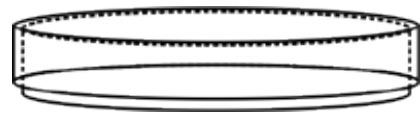

02.270

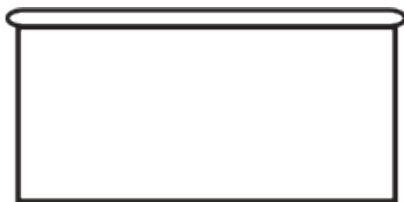

02.272



02.274

02.266 Mac-Cartney Bottles, "SGCLABS", Complete with Aluminum Cap.

Sap Code	Cat No.	Capacity(ml)	Minimum Qty/pack	Price/Piece.
MC-B-5	266/5	5	25	19.50
MC-B-15	266/15	15	25	23.50
MC-B-30	266/30	30	25	34.00
MC-B-60	266/60	60	25	62.00

02.268 Bottles, B.O.D. with interchangeable stopper "SGCLABS",

Sap Code	Cat No.	Capacity (ml)	Price/Piece.
BOD-B-125	268/125	125	280.00
BOD-B-300	268/300	300	350.00

DISHES
02.270 Petri Dishes, "SGCLABS", Boro 33 Glass

Sap Code	Cat No.	O.D.x Ht. (ml approx)	Price/Piece.
PD-50	270/50	50x17	86.00
PD-62	270/62	62x17	93.00
PD-80	270/80	80x17	102.00
PD-100	270/100	100x17	105.00

02.272 Dishes Crystallizing, "SGCLABS", with / without Spout.

Sap Code	Cat No.	O.D.x Ht. (mm approx)	Capacity (ml approx)	Price/Piece.
DC-20	272/20	40 X 25	20	37.00
DC-40	272/40	50 X 30	40	46.00
DC-60	272/60	60 X 35	60	65.00
DC-100	272/100	70 X 40	100	84.00
DC-150	272/150	80 X 45	150	110.00
DC-300	272/300	100 X 50	300	228.00
DC-500	272/500	115 X 65	500	275.00
DC-1000	272/1000	150 X 75	1000	378.00
DC-2000	272/2000	190 X 100	2000	565.00

02.274 Dishes Evaporating, "SGCLABS", Flat Bottom, with Spout.

Sap Code	Cat No.	O.D.x Ht. (mm approx)	Capacity (ml approx)	Price/Piece.
DC-FB-15	274/25	50 X 25	15	80.00
DC-FB-45	274/45	60 X 30	45	100.00
DC-FB-90	274/90	80 X 45	90	148.00
DC-FB-170	274/170	95 X 55	170	230.00
DC-FB-600	274/600	150 X 80	600	385.00
DC-FB-1500	274/1500	200 X 100	1500	710.00

DESICCATORS

02.276 Desiccators Plain with knobbed lid, Ground Flanges, Neutral Glass, supplied with Porcelain perforated plate.

Sap Code	Cat No.	Dia (mm)	Price/Piece.
DP-KL-100	276/100	100	550.00
DP-KL-120	276/120	120	615.00
DP-KL-160	276/160	160	900.00
DP-KL-210	276/210	210	1600.00
DP-KL-240	276/240	240	2400.00
DP-KL-300	276/300	300	3900.00

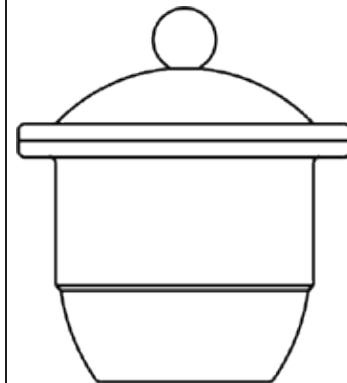

02.276

02.278 Desiccators, Vacuum with tubular Lid, Ground Flanges, and stopcock, Neutral glass, supplied with perforated porcelain plate.

Sap Code	Cat No.	Dia (mm)	Price/Piece.
DV-TL-160	278/160	160	1410.00
DV-TL-210	278/210	210	2575.00
DV-TL-240	278/240	240	3700.00
DV-TL-300	278/300	300	5940.00

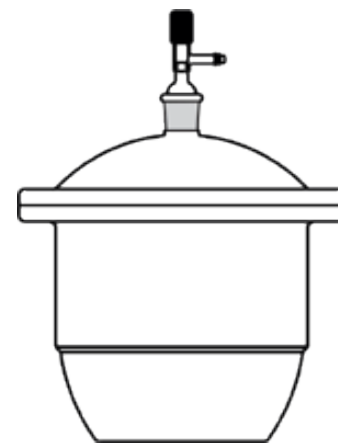

02.278

JARS

02.280 Specimen Jars, "SGCLABS", with Bakelite screw cap and Rubber liner, suitable for Culture, Autoclaveable.

Sap Code	Cat No.	O.D.x Ht. (mm approx)	Capacity (mm approx)	Price/Piece.
SJ-B-5075	280/5075	50 X 75	100	144.00
SJ-B-60110	280/60110	60 X 110	250	184.00
SJ-B-75130	280/75130	75 X 130	500	280.00
SJ-B-90185	280/90185	90 X 185	1000	535.00



02.280

02.282 Jars, Rectangular, Museum, Neutral glass with cover.

Sap Code	Cat No.	Height (mm)	Length (mm)	Breadth (mm)	Price/Piece.
JR-M-NG-140	282/140	140	215	100	725.00
JR-M-NG-210	282/210	210	170	130	815.00
JR-M-NG-220	282/220	220	140	140	720.00
JR-M-NG-225	282/225	225	225	125	1250.00
JR-M-NG-250	282/250	250	250	150	1600.00

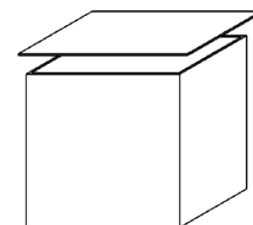

02.282

02.284 Jars-Bell, Round Bottom, Edge Ground "SGCLABS",

Sap Code	Cat No.	O.D.x Height (mm approx)	Price/Piece.
JB-RB-EG-450	284/450	300x450	8950.00
JB-RB-EG-400	284/400	300x400	8820.00
JB-RB-EG-350	284/350	200x350	4800.00

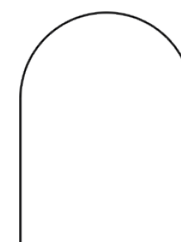

02.284

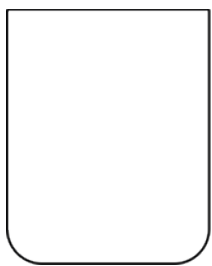

02.286

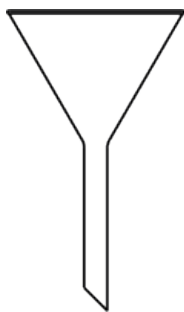

02.288

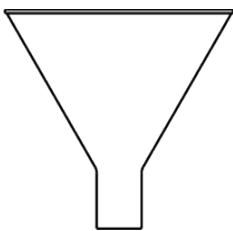

02.290

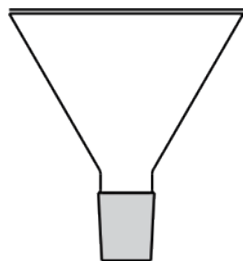

02.292

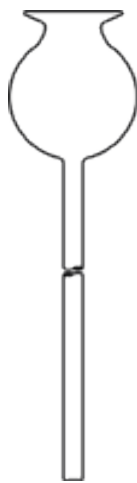

02.292

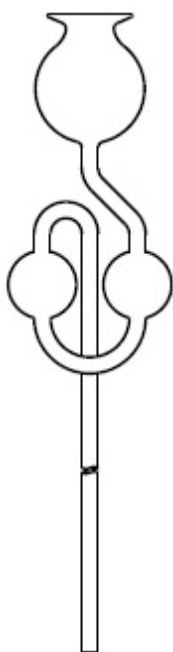

02.294

02.286 Jars-Cylindrical, Fermentation "SGCLABS",

Sap Code	Cat No.	O.D.x Height (mm approx)	Price/Piece.
JC-F-320	286/320	220x320	5150.00
JC-F-455	286/455	220x455	7000.00

FUNNELS

02.288 Funnel Filtering, "SGCLABS", 60° angle, with stem.

Sap Code	Cat No.	Diameter (mm)	Bottom Tube (Dia mm)	To suit Filter Paper (Dia mm)	Price/Piece.
FF-S-35	288/35	35	6	45-55	28.00
FF-S-45	288/45	45	6	55-70	31.00
FF-S-55	288/55	55	8	70-90	33.50
FF-S-70	288/70	70	8	110-15	44.00
FF-S-80	288/80	80	8	125-10	48.00
FF-S-100	288/100	100	10	150-185	78.00
FF-S-120	288/120	120	16	185-240	180.00
FF-S-150	288/150	150	16	240-270	240.00
FF-S-200	288/200	200	24	320-385	490.00

02.290 Funnel-Powder, Short Plain Stem "SGCLABS",

Sap Code	Cat No.	Diameter (mm)	Bottom Tube (Dia mm)	Price/Piece.
FP-PS-55	290/55	55	20	45.00
FP-PS-70	290/70	70	22	52.00
FP-PS-80	290/80	80	24	57.00
FP-PS-100	290/100	100	26	100.00
FP-PS-125	290/125	125	35	190.00
FP-PS-150	290/150	150	35	228.00
FP-PS-200	290/200	200	40	470.00

02.292 Powder Funnel with cone at stem

Sap Code	Cat No.	Diameter (mm)	Bottom Tube (Dia mm)	Price/Piece.
PF-CS-100	292/100	100	24/29	132.00
PF-CS-125	292/125	125	24/29	237.00
PF-CS-150	292/150	150	24/29	307.00
PF-CS-200	292/200	200	24/29	540.00

02.292-30 Thistle Funnel, "SGCLABS", 30 cm stem 36.00

02.294 Thistle Funnel, "SGCLABS", for Kipp's Apparatus 80.00

FLASKS

02.296 Flasks, Erlenmeyer, "SGCLABS", Conical, Narrow mouth, with approx. Graduation.

Sap Code	Cat No.	Capacity (ml)	Approx Neck (OD mm)	Graduation (Interval ml)	Price/Piece.
FC-NM-25	296/25	25	22	–	41.00
FC-NM-50	296/50	50	22	–	48.00
FC-NM-100	296/100	100	22	25	50.00
FC-NM-150	296/150	150	28	25	72.00
FC-NM-250	296/250	250	34	50	80.00
FC-NM-500	296/500	500	34	100	110.00
FC-NM-1000	296/1000	1000	42	200	190.00
FC-NM-2000	296/2000	2000	48	500	345.00
FC-NM-3000	296/3000	3000	48	500	850.00
FC-NM-5000	296/5000	5000	50	500	1350.00

Note : Flasks 25 & 50ml capacity are ungraduated.

02.298 Flasks Erlenmeyer, "SGCLABS", Conical, Wide Mouth, Approx. Graduation

Sap Code	Cat No.	Capacity (ml)	O.D.x Ht (mm approx)	Approx Neck (O.D.mm)	Price/Piece.
FC-WM-100	298/100	100	64 X 105	34	56.00
FC-WM-250	298/250	250	85 X 142	50	79.00
FC-WM-500	298/500	500	105 X 175	50	125.00
FC-WM-1000	298/1000	1000	130 X 220	56	218.00
FC-WM-2000	298/2000	2000	150 X 275	70	600.00

02.300 Flasks Conical, "SGCLABS", Rimless, Suitable for culture.

Sap Code	Cat No.	Capacity (ml)	O.D.x Ht (mm approx)	Approx Neck (O.D.mm)	Price/Piece.
FC-RL-250	300/250	250	78 X 154	25	102.00
FC-RL-750	300/750	750	114 X 210	34	220.00

02.302 Flasks Erlenmeyer, "SGCLABS", Conical, with interchangeable stopper.

Sap Code	Cat No.	Capacity (ml)	Stopper Size	Price/Piece.
FC-S-25	302/25	25	14/23	88.00
FC-S-50	302/50	50	19/26	102.00
FC-S-100	302/100	100	24/29	125.00
FC-S-150	302/150	150	24/29	148.00
FC-S-250	302/250	250	24/29	165.00
FC-S-500	302/500	500	24/29	235.00
FC-S-1000	302/1000	1000	29/32	415.00
FC-S-2000	302/2000	2000	34/35	750.00

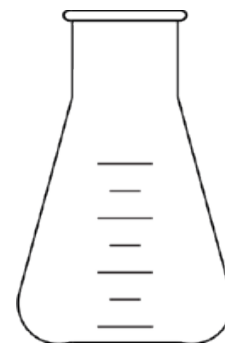

02.296

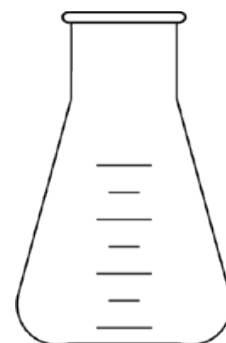

02.298

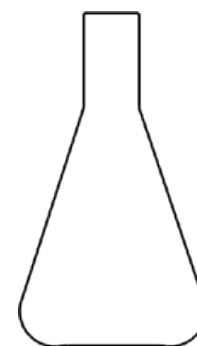

02.300

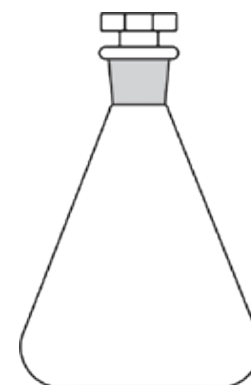

02.302

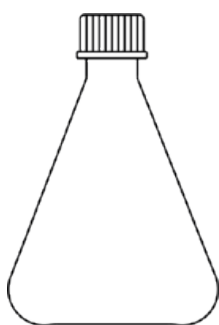

02.304

02.304 Flasks Erlenmeyer, "SGCLABS", Conical, with Screw Cap and liner.

Sap Code	Cat No.	Capacity (ml)	Thread Size	Price/Piece.
FC-SC-25	304/25	25	GL-25	84.00
FC-SC-50	304/50	50	GL-25	102.00
FC-SC-100	304/100	100	GL-32	118.00
FC-SC-150	304/150	150	GL-32	148.00
FC-SC-250	304/250	250	GL-32	160.00
FC-SC-500	304/500	500	GL-32	215.00
FC-SC-1000	304/1000	1000	GL-45	380.00
FC-SC-2000	304/2000	2000	GL-45	740.00

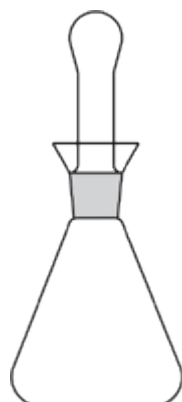

02.306

02.306 Flasks Iodine, "SGCLABS", with funnel shaped cup and stopper.

Sap Code	Cat No.	Capacity (ml)	Stopper Size	Price/Piece.
FI-FS-100	306/100	100	24/29	130.00
FI-FS-250	306/250	250	24/29	165.00
FI-FS-500	306/500	500	24/29	194..00
FI-FS-1000	306/1000	1000	24/29	425.00

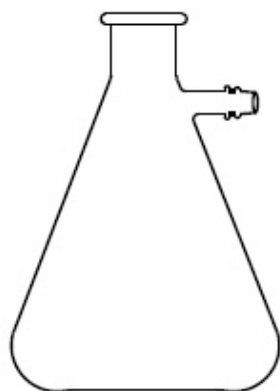

02.308

02.308 Flasks Filtering, "SGCLABS", Heavy wall, with tubulation.

Sap Code	Cat No.	Capacity (ml)	Price/Piece.
FF-HW-100	308/100	100	144.00
FF-HW-250	308/250	250	238.00
FF-HW-500	308/500	500	314.00
FF-HW-1000	308/1000	1000	470.00
FF-HW-2000	308/2000	2000	902.00
FF-HW-5000	308/5000	5000	3000.00
FF-HW-10000	308/10000	*10000	5600.00
FF-HW-20000	308/20000	*20000	9100.00

Note : * Bottle shape

02.310 Flasks, Kjeldhal, "SGCLABS", Round Bottom, long neck, Plain

Sap Code	Cat No.	Capacity (ml)	OD x Ht. Approx. mm.	Price/Piece.
FK-RB-10	310/10	10	30 X 180	44.00
FK-RB-30	310/30	30	40 X 180	60.00
FK-RB-50	310/50	50	45 X 200	90.00
FK-RB-100	310/100	100	60 X 220	102.00
FK-RB-300	310/300	300	80 X 300	185.00
FK-RB-500	310/500	500	98 X 325	278.00
FK-RB-800	310/800	800	115 X 350	376.00

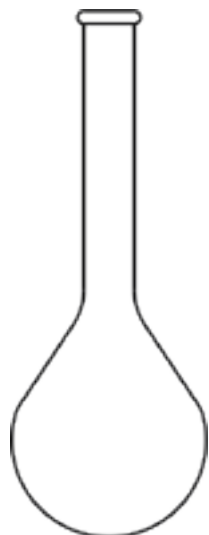

02.310

02.312 Flasks Distillation, "SGCLABS", with side tube at 75° angle.

Sap Code	Cat No.	Capacity (ml)	O.D. x Ht. Approx. mm	Neck O.D Approx. Mm	Price/Piece.
FD-ST-100	312/100	100	64x2100	21	124.00
FD-ST-125	312/125	125*	68x214	19	125.00
FD-ST-100	312/250	250	88x226	25	148.00
FD-ST-100	312/500	500	110x250	28	200.00

Note: * As per IP 123/64

02.314 Flasks Boiling, "SGCLABS", Round Bottom.

Sap Code	Cat No.	Capacity (ml)	Price/Piece.
FB-RB-50	314/50	50	46.00
FB-RB-100	314/100	100	60.00
FB-RB-150	314/150	150	72.00
FB-RB-250	314/250	250	80.00
FB-RB-500	314/500	500	120.00
FB-RB-1000	314/1000	1000	188.00
FB-RB-2000	314/2000	2000	360.00
FB-RB-3000	314/3000	3000	950.00
FB-RB-5000	314/5000	5000	1350.00
FB-RB-10000	314/10000	10000	2850.00
FB-RB-20000	314/20000	20000	6100.00

02.316 Flasks Boiling, "SGCLABS", Flat Bottom.

Sap Code	Cat No.	Capacity (ml)	Price/Piece.
FB-FB-50	316/50	50	46.00
FB-FB-100	316/100	100	60.00
FB-FB-150	316/150	150	72.00
FB-FB-250	316/250	250	80.00
FB-FB-500	316/500	500	120.00
FB-FB-1000	316/1000	1000	188.00
FB-FB-2000	316/2000	2000	360.00
FB-FB-3000	316/3000	3000	950.00
FB-FB-5000	316/5000	5000	1350.00
FB-FB-10000	316/10000	10000	2800.00
FB-FB-20000	316/20000	20000	6100.00

02.318 Flasks Culture, Haffkine "SGCLABS",

Sap Code	Cat No.	Capacity (ml)	Approx OD x Ht. (mm)	Price/Piece.
FC-H-3000	318/3000	3000	241 X 273	1420.00
FC-H-4000	318/4000	4000	245 X 310	1700.00

02.320 Flasks Loflo, "SGCLABS", Capacity 3000 ml.(O.D. x Ht.) 260 x 205 mm approx., Approx Neck.

1760.00

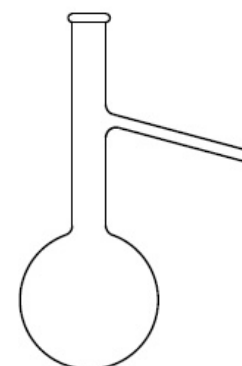

02.312

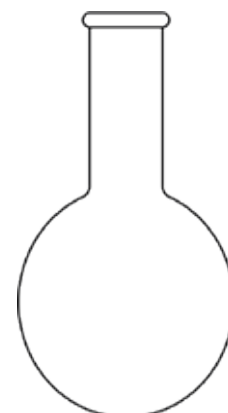

02.314

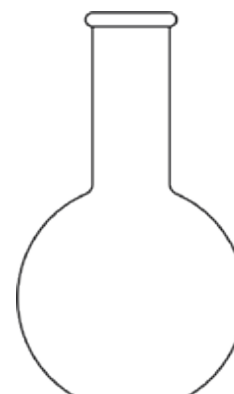

02.316



02.318

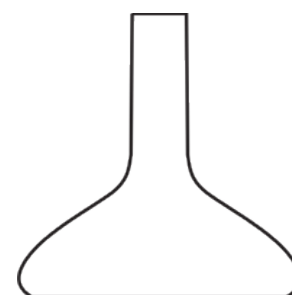

02.320

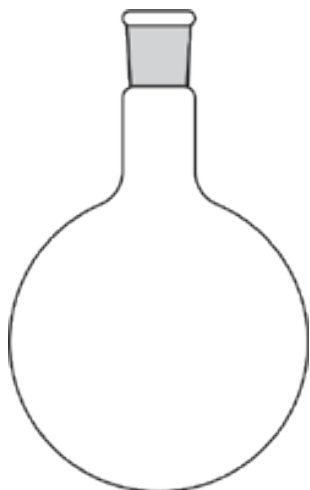

02.322

02.322 Flasks Round Bottom, "SGCLABS", with socket.

Sap Code	Cat No.	Capacity(ml)	Socket	Price/Piece.
FRB-WS-5	322/5	5	14/23	48.00
FRB-WS-10	322/10	10	14/23	49.00
FRB-WS-25	322/25	25	14/23	65.00
FRB-WS-25	322/25	25	19/26	67.00
FRB-WS-50	322/50	50	19/26	78.00
FRB-WS-50	322/50	50	24/29	78.00
FRB-WS-100	322/100	100	19/26	100.00
FRB-WS-100	322/100	100	24/29	92.00
FRB-WS-150	322/150	150	19/26	106.00
FRB-WS-150	322/150	150	24/29	106.00
FRB-WS-250	322/250	250	19/26	120.00
FRB-WS-250	322/250	250	24/29	120.00
FRB-WS-500	322/500	500	19/26	172.00
FRB-WS-500	322/500	500	24/29	163.00
FRB-WS-1000	322/1000	1000	24/29	260.00
FRB-WS-2000	322/2000	2000	24/29	475.00
FRB-WS-3000	322/3000	3000	34/35	1140.00
FRB-WS-5000	322/5000	5000	34/35	1750.00
FRB-WS-10000	322/10000	10000	55/44	3420.00
FRB-WS-20000	322/20000	20000	55/44	6840.00

Note: For long neck flasks 10% will be charged extra and also do mention the Short or Medium Neck, while placing order. Flasks with other sizes of sockets are also available on the same rates as per the capacity.



02.324

02.324 Flasks Flat Bottom, "SGCLABS", with socket.

Sap Code	Cat No.	Capacity(ml)	Socket	Price/Piece.
FFB-WS-5	324/5	5	14/23	48.00
FFB-WS-10	324/10	10	14/23	49.00
FFB-WS-25	324/25	25	14/23	65.00
FFB-WS-25	324/25	25	19/26	67.00
FFB-WS-50	324/50	50	19/26	78.00
FFB-WS-50	324/50	50	24/29	78.00
FFB-WS-100	324/100	100	19/26	100.00
FFB-WS-100	324/100	100	24/29	92.00
FFB-WS-150	324/150	150	19/26	106.00
FFB-WS-150	324/150	150	24/29	106.00
FFB-WS-250	324/250	250	19/26	120.00
FFB-WS-250	324/250	250	24/29	120.00
FFB-WS-500	324/500	500	19/26	172.00
FFB-WS-500	324/500	500	24/29	163.00
FFB-WS-1000	324/1000	1000	24/29	260.00
FFB-WS-2000	324/2000	2000	24/29	475.00
FFB-WS-3000	324/3000	3000	34/35	1140.00
FFB-WS-5000	324/5000	5000	34/35	1750.00
FFB-WS-10000	324/10000	10000	55/44	3420.00
FFB-WS-20000	324/20000	20000	55/44	6840.00

Note: For long neck flasks 10% will be charged extra and also do mention the Short or Medium Neck, while placing order. Flasks with other sizes of sockets are also available on the same rates as per the capacity.

02.326 Flasks Round bottom, Two Neck, "SGCLABS", (Side neck at Angle or Parallel)

Sap Code	Cat No.	Capacity (ml)	Centre Socket	Side Socket	Price/Piece.
FRB-2N-25	326/25	25	19/26	14/23	140.00
FRB-2N-50	326/50	50	19/26	14/23	150.00
FRB-2N-100	326/100	100	24/29	14/23	154.00
FRB-2N-250	326/250	250	24/29	14/23	215.00
FRB-2N-250	326/250	250	24/29	19/26	216.00
FRB-2N-500	326/500	500	24/29	14/23	304.00
FRB-2N-500	326/500	500	24/29	19/26	305.00
FRB-2N-1000	326/1000	1000	24/29	14/23	418.00
FRB-2N-1000	326/1000	1000	24/29	19/26	418.00
FRB-2N-2000	326/2000	2000	34/35	19/26	760.00
FRB-2N-2000	326/2000	2000	24/29	19/26	760.00
FRB-2N-3000	326/3000	3000	34/35	19/26	1520.00
FRB-2N-5000	326/5000	5000	34/35	24/29	2225.00
FRB-2N-5000	326/5000	5000	34/35	19/26	2225.00
FRB-2N-10000	326/10000	10000	55/44	24/29	4140.00
FRB-2N-20000	326/20000	20000	55/44	24/29	7450.00

Note: Flasks with other combination of necks can also be supplied. Please do mention side neck at angle or parallel, while placing order. please suffix 'a' for side neck at angle and 'p' for parallel.

02.328 Flask Round Bottom, Three Neck, "SGCLABS", (Side necks at angle or parallel).

Sap Code	Cat No.	Capacity (ml)	Centre Socket	Side Socket	Price/Piece.
FFB-3N-100	328/100	100	24/29	14/23	209.00
FFB-3N-250	328/250	250	24/29	14/23	290.00
FFB-3N-250	328/250	250	24/29	19/26	292.00
FFB-3N-500	328/500	500	24/29	14/23	408.00
FFB-3N-500	328/500	500	24/29	19/26	410.00
FFB-3N-1000	328/1000	1000	24/29	19/26	515.00
FFB-3N-1000	328/1000	1000	34/35	19/26	518.00
FFB-3N-2000	328/2000	2000	24/29	19/26	895.00
FFB-3N-2000	328/2000	2000	34/35	24/29	900.00
FFB-3N-3000	328/3000	3000	34/35	24/29	1995.00
FFB-3N-5000	328/5000	5000	34/35	19/26	2800.00
FFB-3N-10000	328/10000	10000	55/44	24/29	4940.00
FFB-3N-20000	328/20000	20000	55/44	24/29	8450.00

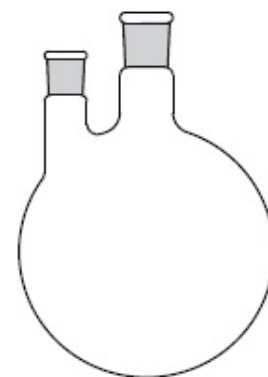

02.326-P



02.326-A

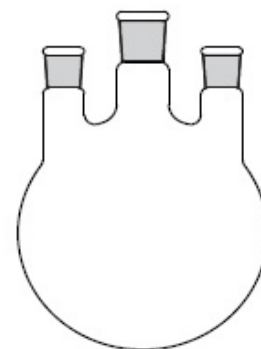

02.328-P

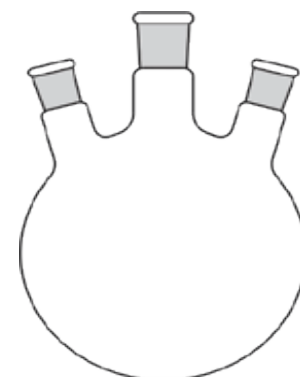

02.328-A

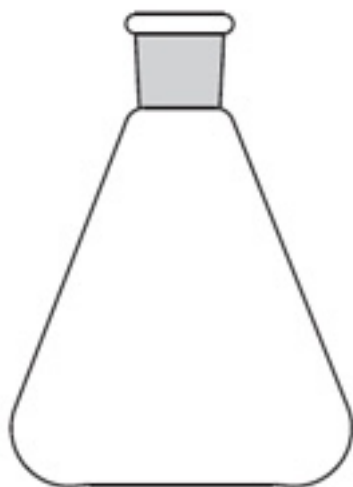

02.330

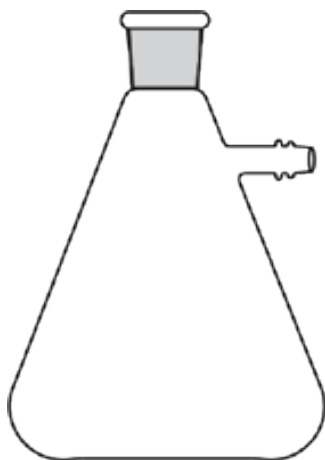

02.332

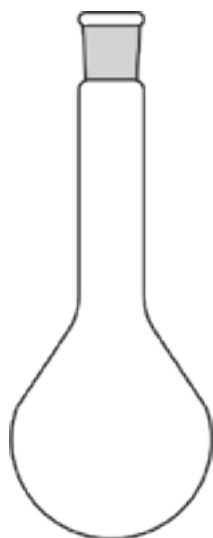

02.334

Note : Four Neck flasks above 500ml can be supplied on 15% extra cost
Other combination of sockets can also be supplied on request.

02.330 Flask Erlenmeyer, "SGCLABS", Conical, with socket.

Sap Code	Cat No.	Capacity(ml)	Socket	Price/Piece.
CF-WS-25	330/25	25	14/23	65.00
CF-WS-50	330/50	50	14/23	78.00
CF-WS-50	330/50	50	19/26	78.00
CF-WS-100	330/100	100	19/26	92.00
CF-WS-100	330/100	100	24/29	95.00
CF-WS-150	330/150	150	19/26	110.00
CF-WS-150	330/150	150	24/29	110.00
CF-WS-250	330/250	250	19/26	120.00
CF-WS-250	330/250	250	24/29	118.00
CF-WS-250	330/250	250	29/32	128.00
CF-WS-500	330/500	500	19/26	172.00
CF-WS-500	330/500	500	24/29	160.00
CF-WS-500	330/500	500	29/32	180.00
CF-WS-1000	330/1000	1000	24/29	295.00
CF-WS-1000	330/1000	1000	34/35	310.00
CF-WS-2000	330/2000	2000	24/29	625.00
CF-WS-2000	330/2000	2000	34/35	630.00

02.332 Flasks, Buchner, "SGCLABS", Filtration, Heavy wall, with tubulation and socket.

Sap Code	Cat No.	Capacity(ml)	Socket	Price/Piece.
FB-FHW-100	332/100	100	19/26	160.00
FB-FHW-250	332/250	250	24/29	308.00
FB-FHW-500	332/500	500	24/29	380.00
FB-FHW-1000	332/1000	1000	24/29	550.00
FB-FHW-1000	332/1000	1000	34/35	555.00
FB-FHW-2000	332/2000	2000	34/35	1050.00

02.334 Flasks, Kjeldahl, "SGCLABS", with Socket.

Sap Code	Cat No.	Capacity(ml)	Socket	Price/Piece.
FK-WS-50	334/50	50	19/26	104.00
FK-WS-100	334/100	100	19/26	111.00
FK-WS-100	334/100	100	24/29	150.00
FK-WS-300	334/300	300	24/29	222.00
FK-WS-500	334/500	500	24/29	308.00
FK-WS-800	334/800	800	24/29	390.00
FK-WS-800	334/800	800	29/32	415.00

02.336 Flasks, Florentine, "SGCLABS", with Socket.

Sap Code	Cat No.	Capacity(ml)	Socket	Price/Piece.
FF-WS-50	336/50	50	19/26	100.00
FF-WS-100	336/100	100	19/26	110.00
FF-WS-100	336/100	100	24/29	145.00
FF-WS-300	336/300	300	24/29	220.00
FF-WS-500	336/500	500	24/29	304.00
FF-WS-800	336/800	800	24/29	385.00
FF-WS-800	336/800	800	24/29	410.00

CONDENSERS

03.338 Air Condensers, "SGCLABS", .

Sap Code	Cat No.	Socket	Cone	Effective length (mm)	Price/Piece.
AC-SC-200	338/200	14/23	14/23	200	110.00
AC-SC-200	338/200	19/26	19/26	200	130.00
AC-SC-250	338/250	24/29	24/29	250	172.00
AC-SC-400	338/400	19/26	19/26	400	198.00
AC-SC-500	338/500	24/29	24/29	500	248.00
AC-C-750	340/750	—	19/26	750	120.00
AC-C-750-1	340/750	—	24/29	750	125.00

03.342 Liebig Condensers, "SGCLABS", .

Sap Code	Cat No.	Socket	Cone	Effective length (mm)	Price/Piece.
LC-SC-150	342/150	14/23	14/23	150	165.00
LC-SC-200	342/200	19/26	19/26	200	188.00
LC-SC-300	342/300	19/26	19/26	300	230.00
LC-SC-300	342/300	24/29	24/29	300	255.00
LC-SC-400	342/400	19/26	19/26	400	275.00
LC-SC-400	342/400	24/29	24/29	400	284.00
LC-SC-250	342/250	29/32	29/32	250	315.00
LC-SC-400	342/400	29/32	29/32	400	360.00

03.344 Coil Condensers, "SGCLABS", Graham, Coil Distillate Type.

Sap Code	Cat No.	Socket	Cone	Effective length (mm)	Price/Piece.
CC-CD-300	344/300	24/29	24/29	300	440.00
CC-CD-400	344/400	24/29	24/29	400	502.00
CC-CD-500	344/500	24/29	24/29	500	520.00

03.346 Coil Condensers, "SGCLABS", Graham, Jacket Distillate Type.

02.336

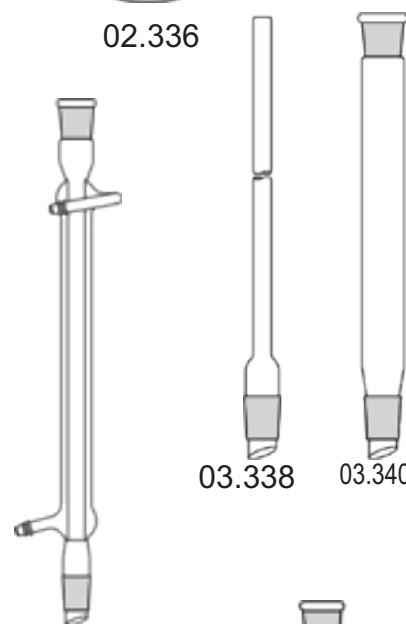

03.338

03.340

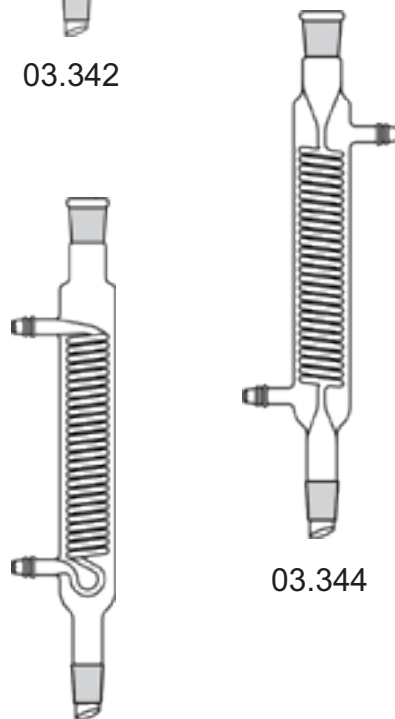

03.342

03.344

03.346

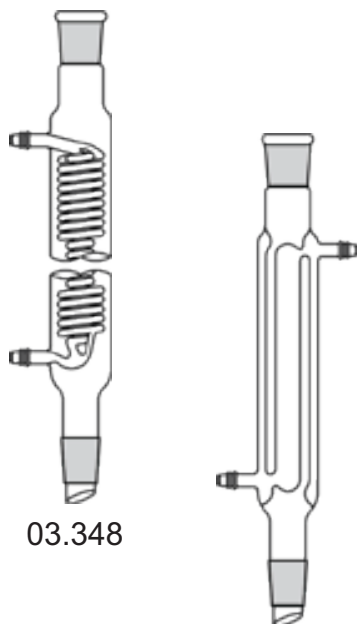

03.348

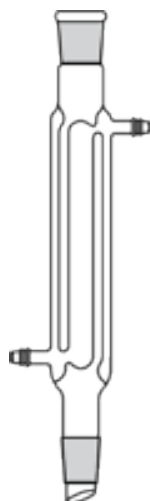

03.350

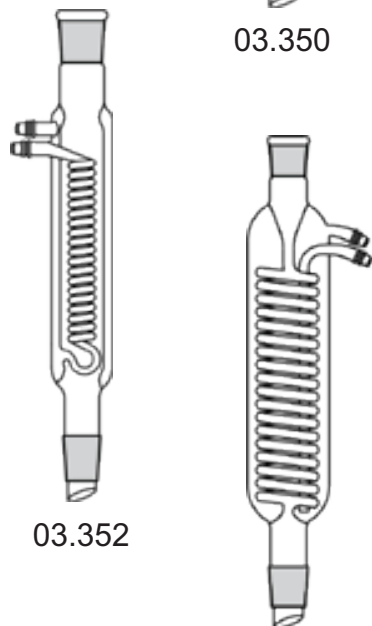

03.352

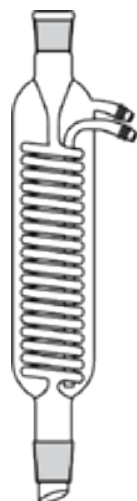

03.354

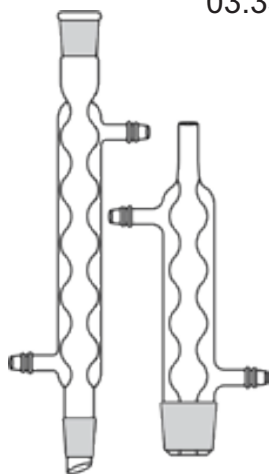

03.356

Sap Code	Cat No.	Socket	Cone	Effective length (mm)	Price/Piece.
CC-JD-200	346/200	19/26	19/26	200	354.00
CC-JD-300	346/300	19/23	19/23	300	404.00
CC-JD-300	346/300	24/29	24/29	300	445.00
CC-JD-165	346/165	29/32	29/32	165	395.00
CC-JD-320	346/320	29/32	29/32	320	502.00

03.348 Double Coil Condensers, "SGCLABS", with common inlet.

Sap Code	Cat No.	Socket	Cone	Effective length (mm)	Price/Piece.
DCC-SC-200	348/200	19/26	19/26	200	840.00
DCC-SC-200	348/200	24/29	24/29	200	855.00
DCC-SC-350	348/350	34/35	34/35	350	2100.00
DCC-SC-450	348/450	34/35	34/35	450	3000.00
DCC-SC-600	348/600	34/35	34/35	600	3500.00

03.350 Davies Condensers, "SGCLABS", (Double Surface).

Sap Code	Cat No.	Socket	Cone	Effective length (mm)	Price/Piece.
DC-SC-150	350/150	19/26	19/26	150	395.00
DC-SC-200	350/200	19/26	19/26	200	435.00
DC-SC-200	350/200	24/29	24/29	200	445.00
DC-SC-200	350/200	29/32	29/32	200	455.00
DC-SC-300	350/300	24/29	24/29	300	530.00

03.352 Jacketed Coil Condensers, "SGCLABS", .

Sap Code	Cat No.	Socket	Cone	Effective length (mm)	Price/Piece.
JCC-SC-160	352/160	19/26	19/26	160	445.00
JCC-SC-160	352/160	24/29	24/29	160	455.00
JCC-SC-160	352/160	29/32	29/32	160	474.00
JCC-SC-200	352/200	19/26	19/26	200	488.00
JCC-SC-200	352/200	24/29	24/29	200	498.00
JCC-SC-300	352/300	19/26	19/26	300	575.00
JCC-SC-300	352/300	24/29	24/29	300	585.00

03.354 Inland Revenue Condensers, "SGCLABS", .

Sap Code	Cat No.	Socket	Cone	Effective length (mm)	Price/Piece.
IRC-SC-200	354/200	19/26	19/26	200	580.00
IRC-SC-200	354/200	24/29	24/29	200	595.00

03.356 Allihn Condensers, "SGCLABS", (Bulb Condenser).

Sap Code	Cat No.	Socket	Cone	Effective length (mm)	Price/Piece.
AC-C-200	356/200	—	34/35	200	288.00
AC-C-200-1	356/200-1	—	40/38	200	294.00
AC-C-250	356/250	—	50/42	250	480.00

03.358 Friedrich Condensers, "SGCLABS",

Sap Code	Cat No.	Socket	Cone	Effective length (mm)	Price/Piece.
FC-SC-200	358/200	19/26 or 24/29	19/26 or 24/29	200	880.00

03.360 Ether Condensers, "SGCLABS",

Sap Code	Cat No.	Socket	Cone	Effective length (mm)	Price/Piece.
EC-SC-200	360/200	19/26	24/29	200	1500.00

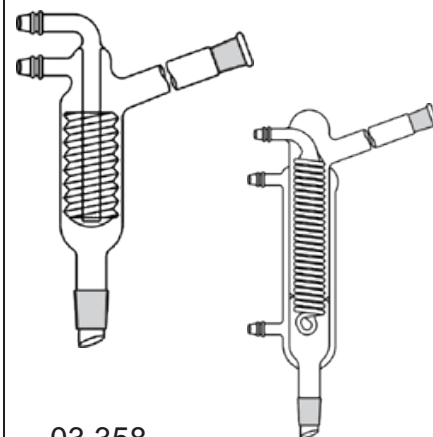

03.358

03.360

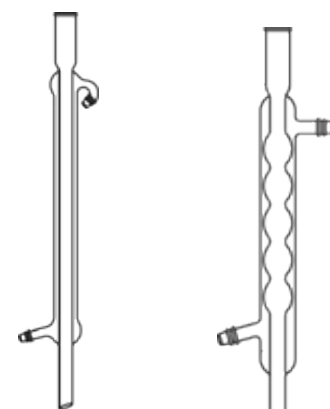

03.362

03.364

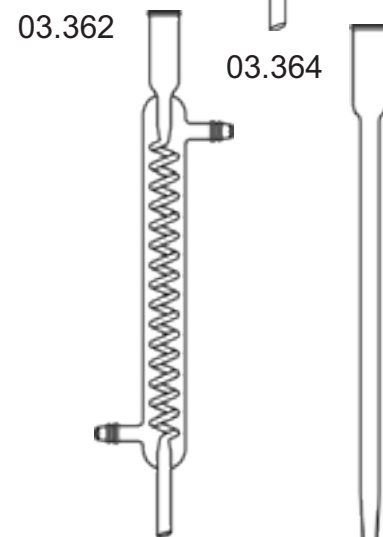

03.366

03.368

CONDENSERS WITHOUT JOINTS

03.362 Liebig Condensers "SGCLABS",

Sap Code	Cat No.	Effective Length mm	Price/Piece.
LC-200	362/200	200	148.00
LC-300	362/300	300	166.00
LC-400	362/400	400	195.00

03.364 Allihn Condensers, "SGCLABS", (Bulb Condenser).

Sap Code	Cat No.	Effective Length mm	Price/Piece.
AC-BC-200	364/200	200	240.00
AC-BC-300	364/300	300	298.00
AC-BC-400	364/400	400	340.00

03.366 Coil Condensers, "SGCLABS", (Graham Condenser).

Sap Code	Cat No.	Effective Length mm	Price/Piece.
CC-GC-200	366/200	200	292.00
CC-GC-300	366/300	300	344.00
CC-GC-400	366/400	400	400.00

03.368 Air Condensers, "SGCLABS",

Sap Code	Cat No.	Effective Length mm	Price/Piece.
AC-400	368/400	400	72.00
AC-600	368/600	600	88.00
AC-750	368/750	750	125.00

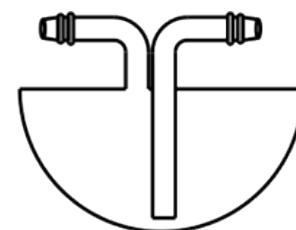

03.370

03.370 Condensers, "SGCLABS", Bulb shape, suitable for 1000 ml. 320.00

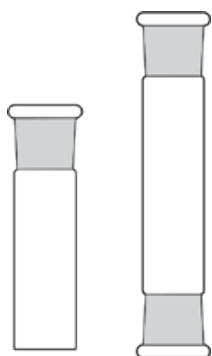

03.372

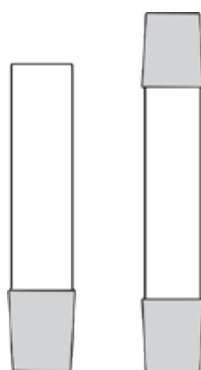

03.376

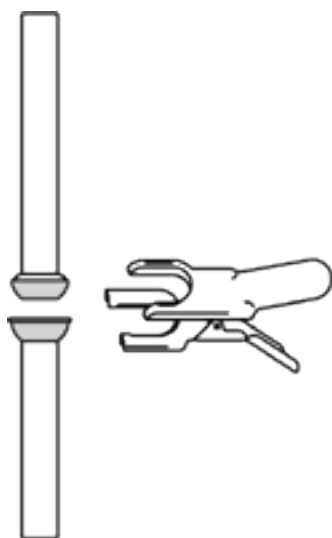

03.380

STANDARD JOINT, STOPPERS & ADAPTERS

03.372 Sockets, "SGCLABS", Single or Double

Sap Code	Cat No.	Socket Size	Price/Piece. Rs.(Single)	Price/Piece. Rs.(Double)
S-S-716	372/716	7/16	30.00	52.00
S-S-1019	372/1019	10/19	30.00	52.00
S-S-1221	372/1221	12/21	33.00	56.00
S-S-1423	372/1423	14/23	33.00	56.00
S-S-1926	372/1926	19/26	39.00	65.00
S-S-2429	372/2429	24/29	46.00	74.00
S-S-2932	372/2932	29/32	67.00	85.00
S-S-3435	372/3435	34/35	84.00	125.00
S-S-4038	372/4038	40/38	110.00	154.00
S-S-4540	372/4540	45/40	154.00	185.00
S-S-5042	372/5042	50/42	165.00	220.00
S-S-5544	372/5544	55/44	220.00	330.00

Note : Sockets with Hooks, 10% extra.

03.376 Cones, "SGCLABS", Single or Double

Sap Code	Cat No.	Cone Size	Price/Piece. Rs.(Single)	Price/Piece. Rs.(Double)
C-S-716	376/716	7/16	30.00	52.00
C-S-1019	376/1019	10/19	30.00	52.00
C-S-1221	376/1221	12/21	33.00	56.00
C-S-1423	376/1423	14/23	33.00	56.00
C-S-1926	376/1926	19/26	39.00	65.00
C-S-2429	376/2429	24/29	46.00	74.00
C-S-2932	376/2932	29/32	67.00	85.00
C-S-3435	376/3435	34/35	84.00	125.00
C-S-4038	376/4038	40/38	110.00	154.00
C-S-4540	376/4540	45/40	154.00	185.00
C-S-5042	376/5042	50/42	165.00	220.00
C-S-5544	376/5544	55/44	220.00	330.00

Note : Cones with tip, 10% extra, for hooks, 10% extra.

03.380 Ball & Socket, "SGCLABS",

Sap Code	Cat No.	Joint	Approx. Bore mm	Price/Piece.
BS-PB-2	380/2	S 13	2	150.00
BS-PB-5	380/5	S 13	5	150.00
BS-PB-9	380/9	S 19	9	178.00
BS-PB-15	380/15	S 29	15	270.00
BS-PB-21	380/21	S 35	21	360.00
BS-PB-32	380/32	S 41	32	920.00

03.384 Stoppers, "SGCLABS", Hollow.

Sap Code	Cat No.	Shape	Cone	Price/Piece.
SH-HH-1019	384/1019	Hexagonal Head	10/19	14.00
SH-HH-1221	384/1221	Hexagonal Head	12/21	14.00
SH-HH-1423	384/1423	Hexagonal Head	14/23	14.00
SH-HH-1926	384/1926	Hexagonal Head	19/26	18.00
SH-HH-2429	384/2429	Hexagonal Head	24/29	28.00
SH-HH-2932	384/2932	Hexagonal Head	29/32	48.00
SH-HH-3435	384/3435	Hexagonal Head	34/35	76.00
SH-PH-4038	386/4038	Penny Head	40/38	140.00
SH-PH-4540	386/4540	Penny Head	45/40	170.00
SH-PH-5042	386/5042	Penny Head	50/42	195.00
SH-PH-5544	386/5544	Penny Head	55/44	210.00



03.384

03.388 Stoppers, "SGCLABS", Solid, Penny Head.

Sap Code	Cat No.	Cone	Price/Piece.
SS-PH-1019	388/1019	10/19	28.00
SS-PH-1423	388/1423	14/23	30.00
SS-PH-1926	388/1926	19/26	40.00
SS-PH-2429	388/2429	24/29	68.00
SS-PH-2932	388/2932	29/32	110.00
SS-PH-3435	388/3435	34/35	195.00



03.388

03.390 Stoppers, "SGCLABS", Solid, Flat Head.

Sap Code	Cat No.	Cone	Price/Piece.
SS-FH-1019	390/1019	10/19	28.00
SS-FH-1423	390/1423	14/23	30.00
SS-FH-1926	390/1926	19/26	40.00
SS-FH-2429	390/2429	24/29	68.00
SS-FH-2932	390/2932	29/32	110.00
SS-FH-3435	390/3435	34/35	195.00



03.390

03.392 Reduction Adapters, "SGCLABS",

Sap Code	Cat No.	Socket	Cone	Price/Piece.
RA-SC-001	392/001	14/23	19/26	55.00
RA-SC-002	392/002	14/23	24/29	60.00
RA-SC-003	392/003	19/26	24/29	58.00
RA-SC-004	392/004	19/26	29/32	74.00
RA-SC-005	392/005	19/26	34/35	82.00
RA-SC-006	392/006	24/29	29/32	78.00
RA-SC-007	392/007	24/29	34/35	89.00
RA-SC-008	392/008	24/29	40/38	112.00
RA-SC-009	392/009	24/29	55/44	184.00
RA-SC-010	392/010	29/32	34/35	104.00
RA-SC-011	392/011	29/32	40/38	130.00

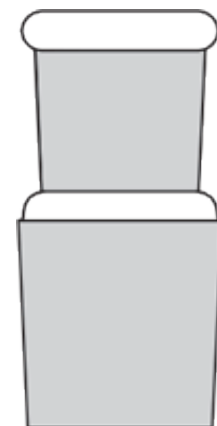

03.392

Note : Reduction adapters of any other combination can also be supplied.

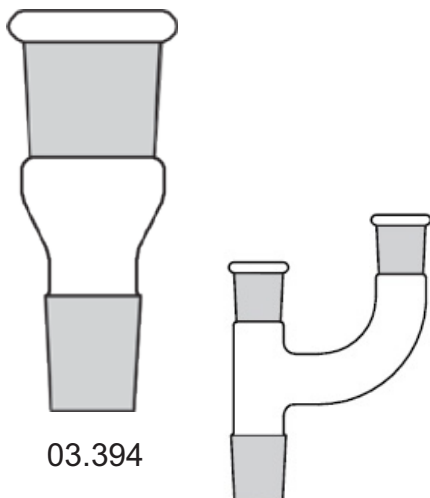

03.394

03.396-001

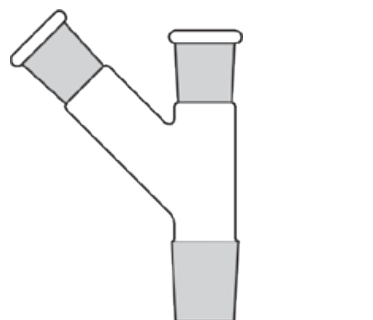

03.396-005

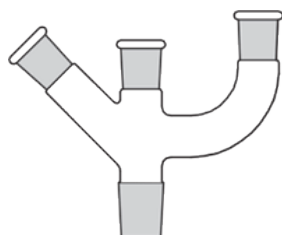

03.396-007

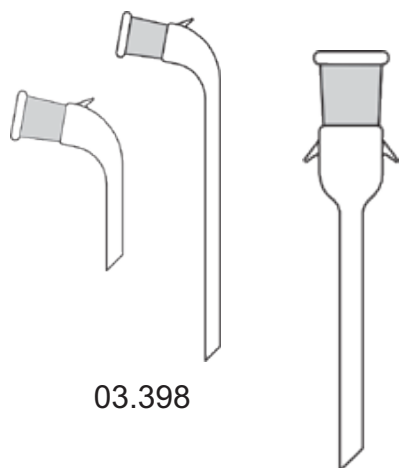

03.398

03.400

03.394 Expansion Adapters, "SGCLABS",

Sap Code	Cat No.	Socket	Cone	Price/Piece.
EA-SC-001	394/001	19/26	14/23	67.00
EA-SC-002	394/002	24/29	14/23	72.00
EA-SC-003	394/003	24/29	19/26	71.00
EA-SC-004	394/004	29/32	19/26	92.00
EA-SC-005	394/005	29/32	24/29	95.00
EA-SC-006	394/006	34/35	19/26	112.00
EA-SC-007	394/007	34/35	24/29	112.00
EA-SC-008	394/001	34/35	29/32	112.00
EA-SC-009	394/001	40/38	24/29	148.00

Note : Expansion adapters of any other combination can also be supplied.

03.396-001 Multiple Adapters, "SGCLABS", with Two Necks Parallel.

Sap Code	Cat No.	Socket	Cone	Price/Piece.
MA-2N-001	396/001	14/23	14/23	130.00
MA-2N-002	396/002	19/26	19/26	160.00
MA-2N-003	396/003	19/26	24/29	160.00
MA-2N-004	396/004	24/29	24/29	186.00

03.396-005 Multiple Adapters, "SGCLABS", with Two Necks

Sap Code	Cat No.	Socket	Cone	Price/Piece.
MA-2N-005	396/005	19/26	19/26	160.00
MA-2N-006	396/006	19/26	24/29	160.00

03.396-007 Multiple Adapters, "SGCLABS", with Three Necks, Two Parallel and one at 45°.

Sap Code	Cat No.	Socket	Cone	Price/Piece.
MA-2N-007	396/007	19/26	24/29	230.00
MA-2N-008	396/008	19/26	29/32	265.00

03.398 Receiver Adapters, "SGCLABS", Plain Bend Short / Long.

Sap Code	Cat No.	Socket	Price/Piece.
RA-PBS-001	398/001	14/23	68.00
RA-PBS-002	398/002	19/26	70.00
RA-PBS-003	398/003	24/29	76.00
RA-PBS-004	398/004	29/32	90.00
RA-PBS-005	398/005	34/35	118.00

03.400 Straight Delivery Adapters, "SGCLABS",

Sap Code	Cat No.	Socket	Price/Piece.
SDA-S-1423	400/1423	14/23	68.00
SDA-S-1926	400/1926	19/26	70.00
SDA-S-2429	400/2429	24/29	76.00
SDA-S-2932	400/2932	29/32	90.00
SDA-S-3435	400/3435	34/35	118.00

03.402 Receiver Adapters, "SGCLABS", Bend with Vent.

Sap Code	Cat No.	Socket	Cone	Price/Piece.
RC-B-001	402/001	14/23	14/23	86.00
RC-B-002	402/002	19/26	19/26	116.00
RC-B-003	402/003	19/26	24/29	116.00
RC-B-004	402/004	24/29	24/29	134.00
RC-B-005	402/005	34/35	34/35	180.00

03.404 Receiver Adapters, "SGCLABS", Bend or Straight with Vacuum Connection.

Sap Code	Cat No.	Socket	Cone	Price/Piece.
RC-BV-001	404/001	14/23	14/23	140.00
RC-BV-002	404/002	19/26	19/26	148.00
RC-BV-003	404/003	19/26	24/29	156.00
RC-BV-004	404/004	24/29	24/29	174.00
RC-BV-005	404/005	34/35	34/35	204.00

03.406 Receiver Adapters, "SGCLABS", with Socket Connections.

Sap Code	Cat No.	Socket	Cone	Price/Piece.
RC-SC-001	406/001	14/23	14/23	140.00
RC-SC-002	406/002	19/26	19/26	156.00
RC-SC-003	406/003	19/26	24/29	160.00

03.408 Receiver Adapters, "SGCLABS", Bend with Multiple Connections (Pig).

Sap Code	Cat No.	Socket	Cone	Price/Piece.
RC-BM-001	408/001	14/23	14/23	285.00
RC-BM-002	408/002	14/23	19/26	300.00
RC-BM-003	408/003	19/26	19/26	310.00

03.410 Receiver Adapters "SGCLABS", Plain Bend.

Sap Code	Cat No.	Socket	Cone	Price/Piece.
RC-PB-001	410/001	19/26	19/26	105.00
RC-PB-002	410/002	19/26	24/29	108.00
RC-PB-003	410/003	24/29	24/29	125.00
RC-PB-004	410/004	34/35	34/35	167.00

STILL / SPLASH / RECOVERY HEADS
03.412 Still Heads, Recovery Bend, "SGCLABS", Sloping (Elbow).

Sap Code	Cat No.	Cone Fitting Flask	Cone Fitting Condenser	Price/Piece..
SH-RC-S-001	412/001	14/23	14/23	78.00
SH-RC-S-002	412/002	19/26	19/26	89.00
SH-RC-S-003	412/003	24/29	19/26	12.00
SH-RC-S-004	412/004	24/29	24/29	112.00
SH-RC-S-005	412/005	34/35	24/29	156.00
SH-RC-S-006	412/006	29/32	29/32	134.00

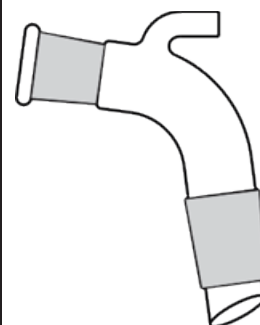

03.402

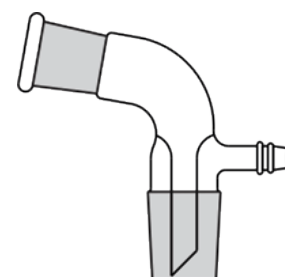

03.404

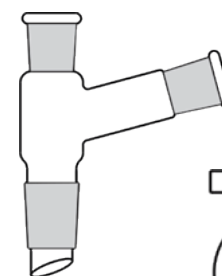

03.406

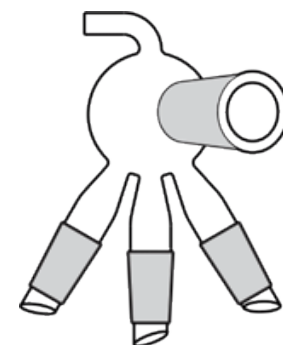

03.408

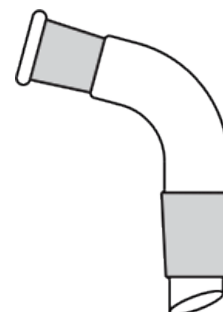

03.410

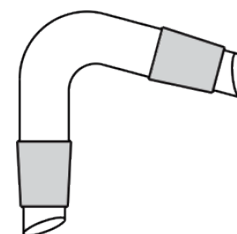

03.412

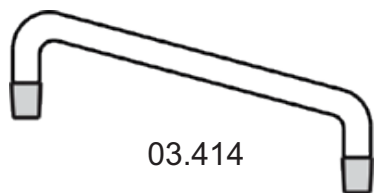

03.414

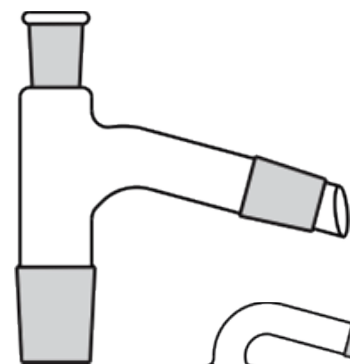

03.416

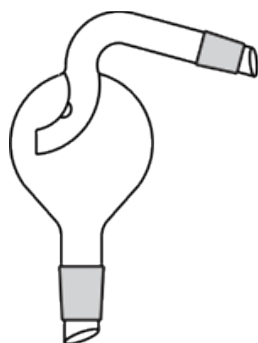

03.418

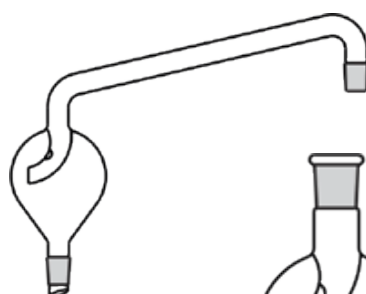

03.420



03.422

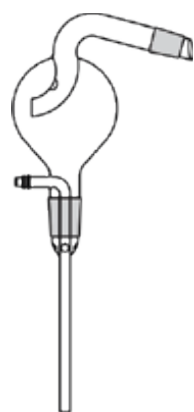

03.424

03.414 Still Heads, Recovery Bend, "SGCLABS", Vertical.

Sap Code	Cat No.	Cone Fitting Flask	Cone Fitting Condenser	Price/Piece..
SH-RC-V-001	414/001	14/23	14/23	115.00
SH-RC-V-002	414/002	19/26	19/26	140.00
SH-RC-V-003	414/003	24/29	24/29	186.00
SH-RC-V-004	414/004	34/35	34/35	280.00

03.416 Recovery Head, "SGCLABS", Sloping with 14/23 Socket.

Sap Code	Cat No.	Cone Fitting Flask	Cone Fitting Condenser	Price/Piece..
RH-S-001	416/001	14/23	14/23	138.00
RH-S-002	416/002	19/26	19/26	160.00
RH-S-003	416/003	24/29	19/26	165.00
RH-S-004	416/004	24/29	24/29	186.00
RH-S-005	416/005	34/35	24/29	218.00

03.418 Splash Heads, "SGCLABS", Pear Shape, Sloping.

Sap Code	Cat No.	Cone Fitting Flask	Cone Fitting Condenser	Price/Piece..
SP-PSS-001	418/001	19/26	19/26	186.00
SP-PSS-002	418/002	24/29	19/26	195.00
SP-PSS-003	418/003	34/35	24/29	223.00
SP-PSS-004	418/004	24/29	24/29	200.00

03.420 Splash Heads, "SGCLABS", Pear Shape, Vertical.

Sap Code	Cat No.	Cone Fitting Flask	Cone Fitting Condenser	Price/Piece..
SH-PSV-001	420/001	19/26	19/26	245.00
SH-PSV-002	420/002	24/29	19/26	250.00
SH-PSV-003	420/003	24/29	24/29	265.00
SH-PSV-004	420/004	34/35	24/29	300.00

03.422 Splash Head Adapter, "SGCLABS",

Sap Code	Cat No.	Cone Fitting Flask	Cone Fitting Condenser	Price/Piece..
SH-A-001	422/001	24/29	19/26	195.00

03.424 Steam Distillation Heads "SGCLABS", Pear Shape, Sloping.

Sap Code	Cat No.	Cone Fitting Flask	Cone Fitting Condenser	Price/Piece..
SDH-PS-001	424/001	24/29	19/26	290.00
SDH-PS-002	424/002	34/35	19/26	295.00

MISCELLANEOUS FITTINGS

03.426 Adapters with Stopcock, "SGCLABS", Cone to Rubber Tubing, Straight/ Rt. angle connection, with Stopcock.

Sap Code	Cat No.	Cone	Price/Piece.
AS-RT-001	426/001	14/23	122.00
AS-RT-002	426/002	19/26	155.00
AS-RT-003	426/003	24/29	144.00
AS-RT-004	426/004	34/35	195.00

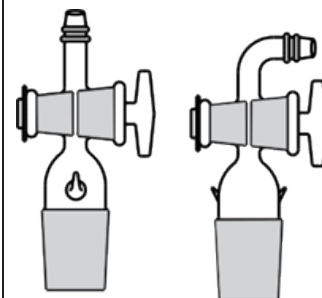

03.426

03.428 Adapters, "SGCLABS", Cone to rubber tubing, straight/ Rt. angle connection.

Sap Code	Cat No.	Cone	Price/Piece.
A-RT-001	428/001	14/23	53.00
A-RT-002	428/002	19/26	62.00
A-RT-003	428/003	24/29	67.00
A-RT-004	428/004	34/35	98.00

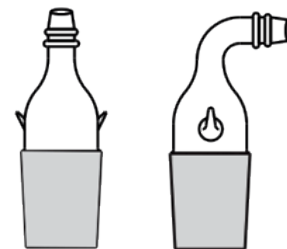

03.428

03.430 Adapters, "SGCLABS", Cone with stem, rubber tubing Right angle connection.

Sap Code	Cat No.	Cone	Price/Piece.
A-CS-001	430/001	14/23	84.00
A-CS-002	430/002	19/26	89.00
A-CS-003	430/003	24/29	95.00

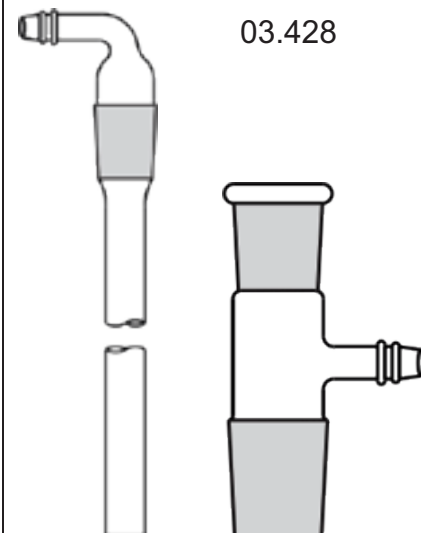

03.430

03.432

03.432 Adapters "SGCLABS", Socket to cone with Tee Connection.

Sap Code	Cat No.	Socket	Cone	Price/Piece..
A-CS-T-001	432/001	14/23	19/26	78.00
A-CS-T-002	432/002	19/26	19/26	87.00
A-CS-T-003	432/003	19/26	24/29	88.00
A-CS-T-004	432/004	24/29	34/35	125.00

03.434 Drying Tube, "SGCLABS",

Sap Code	Cat No.	Cone	Price/Piece.
DT-C-1423	434/1423	14/23	69.00
DT-C-1926	434/1926	19/26	74.00
DT-C-2429	434/2429	24/29	81.00

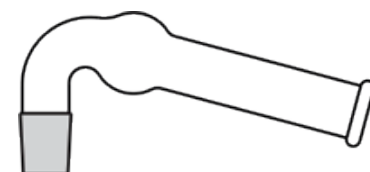

03.434

03.436 Thermometer Pocket, "SGCLABS",

Sap Code	Cat No.	Cone	Price/Piece.
TP-C-1423	436/1423	14/23	52.00
TP-C-1926	436/1926	19/26	58.00
TP-C-2429	436/2429	24/29	65.00



03.436

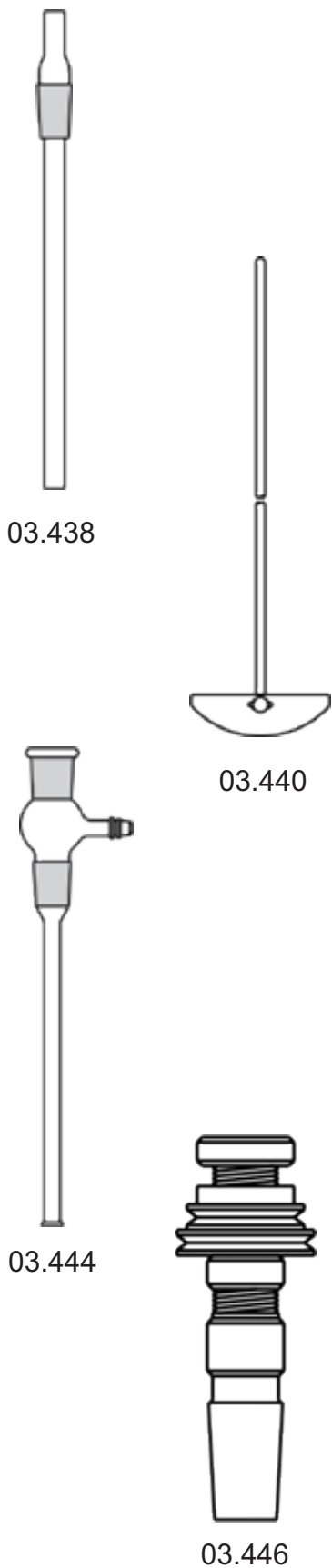

03.438 Air Leak Tube/Gas Inlet Tube, "SGCLABS",

Sap Code	Cat No.	Cone	Price/Piece.
GI-T-1423	438/1423	14/23	74.00
GI-T-1926	438/1926	19/26	79.00
GI-T-2429	438/2429	24/29	84.00
GI-T-3435	438/3435	34/35	110.00

STIRRERS

03.440 Teflon Bladed Stirrers, "SGCLABS", Blade removable from the Stirrer Shaft.

Sap Code	Cat No.	Approx. Shaft Dia mm	Shaft Length mm	Smallest Socket through	Blade Width mm	Price/Piece.
blade will pass						
19/26	52	220.00		TB-S-001	440/001	6 450
TB-S-002	440/002	6	450	24/29	76	270.00
TB-S-003	440/003	8	450	24/29	76	285.00
TB-S-004	440/004	8	450	29/32	100	340.00
TB-S-005	440/005	8	600	34/35	100	362.00
TB-S-006	440/006	10	450	34/35	100	380.00
TB-S-007	440/007	10	600	34/35	125	495.00
TB-S-008	440/008	10	600	50/42	150	585.00

03.442 Shaft for Teflon Bladed stirrers "SGCLABS", .

Sap Code	Cat No.	Approx. Shaft Dia mm	Shaft Length mm	Price/Piece.
STB-S-001	442/001	6	450	80.00
STB-S-002	442/002	8	450	98.00
STB-S-003	442/003	8	600	118.00
STB-S-004	442/004	10	450	128.00
STB-S-005	442/005	10	600	165.00

03.444 Stirrers Guides, "SGCLABS",

Sap Code	Cat No.	To fit Stirrer Shaft	Socket	Cone	Approx Stem Length	Price/Piece.
SG-SC-200	444/200	6 mm	19/26	19/26	200 mm	190.00

03.446 Stuffing Box Glands, "SGCLABS", with brass pulley fitted with ball bearing.

Sap Code	Cat No.	Material of Cone	To fit Stirrer Shaft	Cone	Price/Piece.
SBG-PTFE-001	446/001	PTFE	6 mm	19/26	880.00
SBG-PTFE-002	446/002	PTFE	6-8 mm	24/29	940.00
SBG-PTFE-003	446/003	PTFE	8 mm	34/35	1175.00

03.448 Simple Glands with Cap, "SGCLABS",

Sap Code	Cat No.	To fit Stirrer Shaft	Cone Fitting Condenser	Price/Piece.
SG-C-1423	448/1423	6 mm	14/23	57.00
SG-C-1926	448/1926	6 mm	19/26	60.00
SG-C-2429	448/2429	6 mm	24/29	65.00

SEPARATING/ DROPPING FUNNEL

04.450 Separating Funnel, "SGCLABS", with glass key Stopcock, Interchangeable Stopper, Conical/Pear Shape, Plain Stem.

Sap Code	Cat No.	Capacity (ml)	Price/Piece.
SF-GK-25	450/25	25/30	190.00
SF-GK-50	450/50	50/60	195.00
SF-GK-100	450/100	100/125	258.00
SF-GK-250	450/250	250	356.00
SF-GK-500	450/500	500	456.00
SF-GK-1000	450/1000	1000	660.00
SF-GK-2000	450/2000	2000	1500.00

04.452 Separating Funnel, "SGCLABS", with Screw type, PTFE Needle Valve stopcock, Interchangeable Stopper, Conical/Pear Shape, Plain Stem.

Sap Code	Cat No.	Capacity ml.	Price/Piece.
SF-RF-25	452/25	25/30	205.00
SF-RF-50	452/50	50/60	220.00
SF-RF-100	452/100	100/125	260.00
SF-RF-250	452/250	250	340.00
SF-RF-500	452/500	500	445.00
SF-RF-1000	452/1000	1000	765.00
SR-RF-2000	452/2000	2000	1485.00

04.454 Separating Funnel, "SGCLABS", with PTFE key Stopcock, Interchangeable Stopper, Conical/Pear Shape, Plain Stem.

Sap Code	Cat No.	Capacity ml.	Price/Piece.
SF-PTFE-25	454/25	25/30	420.00
SF-PTFE-50	454/50	50/60	430.00
SF-PTFE-100	454/100	100/125	505.00
SF-PTFE-250	454/250	250	630.00
SF-PTFE-500	454/500	500	865.00
SF-PTFE-1000	454/1000	1000	1175.00
SF-PTFE-2000	425/2000	2000	2100.00



03.448



04.450



04.452



04.454

04.456 Separating Funnels, "SGCLABS", with glass key Stopcock, Interchangeable Stopper, Globe Shape, Plain Stem.

Sap Code	Cat No.	Capacity ml.	Price/Piece.
SF-GK-GS-25	456/25	25/30	190.00
SF-GK-GS-50	456/50	50/60	195.00
SF-GK-GS-100	456/100	100/125	240.00
SF-GK-GS-250	456/250	250	284.00
SF-GK-GS-500	456/500	500	394.00
SF-GK-GS-1000	456/1000	1000	640.00
SF-GK-GS-2000	456/2000	2000	1280.00
SF-GK-GS-3000	456/3000	3000	2375.00
SF-GK-GS-5000	456/5000	5000	3550.00
SF-GK-GS-10000	456/10000	10000	6800.0
SF-GK-GS-20000	456/20000	20000	12000.00

04.458 Separating Funnels, "SGCLABS", with Screw type PTFE Needle Valve Stopcock, Interchangeable Stopper, Globe Shape, Plain Stem.

Sap Code	Cat No.	Capacity (ml)	Price/Piece.
SF-RT-GS-25	458/25	25/30	205.00
SF-RT-GS-50	458/50	50/60	220.00
SF-RT-GS-100	458/100	100/125	260.00
SF-RT-GS-250	458/250	250	340.00
SF-RT-GS-500	458/500	500	445.00
SF-RT-GS-1000	458/1000	1000	765.00
SF-RT-GS-2000	458/2000	2000	1485.00

04.460 Separating Funnels, "SGCLABS", with PTFE key Stopcock, Interchangeable Stopper, Globe Shape, Plain Stem.

Sap Code	Cat No.	Capacity (ml)	Price/Piece.
SF-PTFE-GS-25	460/25	25/30	420.00
SF-PTFE-GS-50	460/50	50/60	430.00
SF-PTFE-GS-100	460/100	100/125	455.00
SF-PTFE-GS-250	460/250	250	590.00
SF-PTFE-GS-500	460/500	500	820.00
SF-PTFE-GS-1000	460/1000	1000	1160.00
SF-PTFE-GS-2000	460/2000	2000	1995.00

04.462 Dropping Funnels, "SGCLABS", Cylindrical, with Interchangeable Stopper and Glass Key / Screw type PTFE Stopcock, Plain Stem.

Sap Code	Cat No.	Capacity (ml)	Price/Piece.
DF-C-GK-50	462/50	50	190.00
DF-C-GK-100	462/100	100	225.00
DF-C-GK-250	462/250	250	330.00

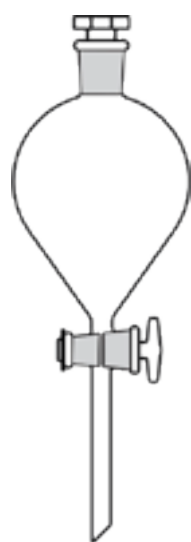

04.456



04.458

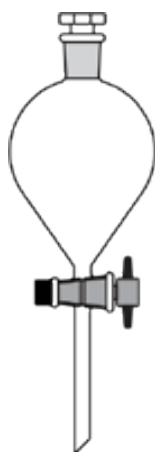

04.460

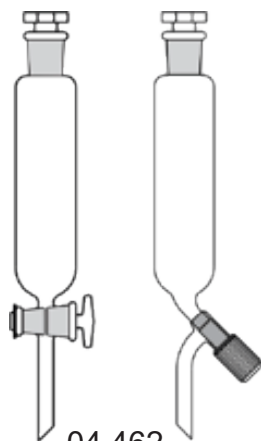

04.462

04.464 Dropping Funnels, "SGCLABS", Cylindrical, Graduated, with Interchangeable Stopper and Glass Key / Screw type PTFE Stopcock, Plain Stem.

Sap Code	Cat No.	Capacity ml.	Price/Piece.
DF-S-PTFE-50	464/50	50	235.00
DF-S-PTFE-100	464/100	100	290.00
DF-S-PTFE-250	464/250	250	425.00

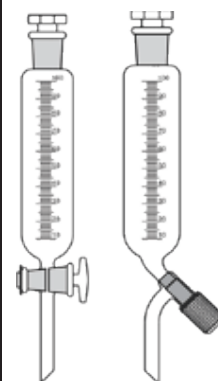

04.464

04.472 Dropping Funnels, "SGCLABS", Cylindrical, open top, with Glass Key / Screw type PTFE Stopcock, Stem with Cone.

Sap Code	Cat No.	Capacity ml.	Cone	Price/Piece.
DF-OT-PTFE-50	472/50	50	19/26	165.00
DF-OT-PTFE-100	472/100	100	19/26	195.00
DF-OT-PTFE-100	472/100	100	24/29	200.00
DF-OT-PTFE-250	472/250	250	19/26	305.00
DF-OT-PTFE-500	472/500	500	24/29	390.00

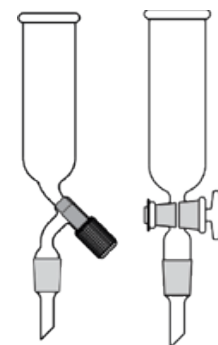

04.472

04.476 Separating Funnels, "SGCLABS", Pear shape, with socket, Glass Key / Screw Type PTFE stopcock, stem with cone but without stopper.

Sap Code	Cat No.	Capacity ml.	Socket Size	Cone Size	Price/Piece.
SF-PS-PTFE-50	476/50	50	14/23	14/23	240.00
SF-PS-PTFE-50	476/50	50	19/26	19/26	250.00
SF-PS-PTFE-100	476/100	100	19/26	19/26	274.00
SF-PS-PTFE-250	476/250	250	19/26	19/26	340.00
SF-PS-PTFE-500	476/500	500	19/26	19/26	445.00
SF-PS-PTFE-500	476/500	500	24/29	24/29	460.00

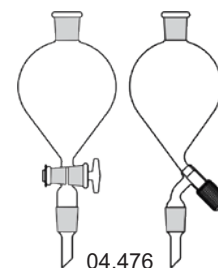

04.476

04.468 Dropping Funnels, "SGCLABS", Cylindrical, with socket, Glass Key/ Screw Type PTFE stopcock, stem with cone but without stopper.

Sap Code	Cat No.	Capacity ml.	Socket Size	Cone Size	Price/Piece.
DF-GS-PTFE-50	468/50	50	14/23	14/23	210.00
DF-GS-PTFE-50	468/50	50	19/26	19/26	220.00
DF-GS-PTFE-100	468/100	100	19/26	19/26	260.00
DF-GS-PTFE-250	468/250	250	19/26	19/26	395.00

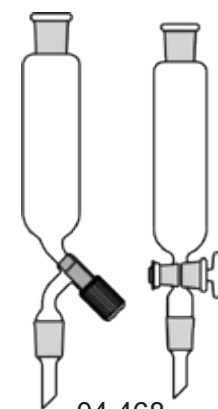

04.468

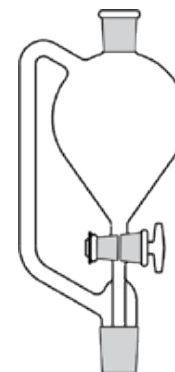
04.484 Pressure Equalizing Funnels, "SGCLABS", Pear shape, with socket, Glass key/ PTFE Key stopcock, stem with cone.

04.484

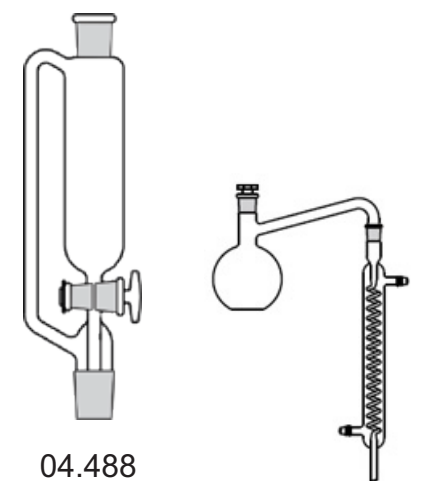

04.488

05.490 A

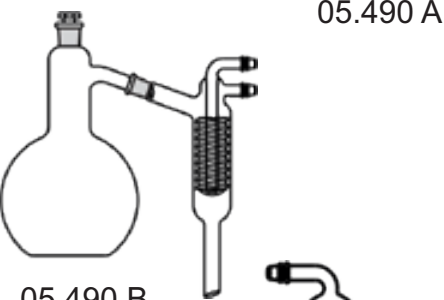

05.490 B

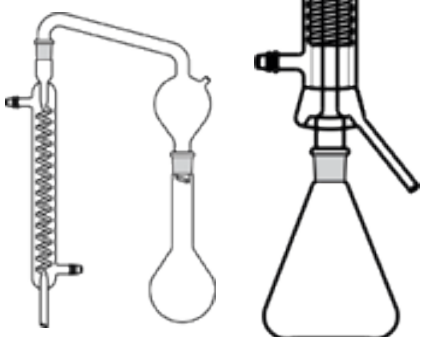

05.492

05.490 C

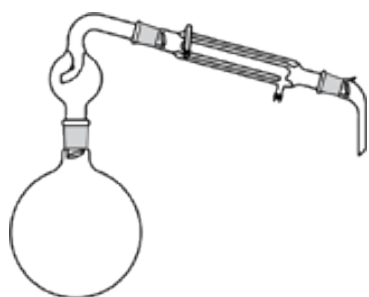

05.494

Sap Code	Cat No.	Capacity ml.	Socket Size	Cone Size	Price/Piece.
PEF-PS-PTFE-100	484/100	100	19/26	19/26	605.00
PEF-PS-PTFE-100	484/100	100	24/29	24/29	615.00
PEF-PS-PTFE-250	484/250	250	19/26	19/26	698.00
PEF-PS-PTFE-250	484/250	250	24/29	24/29	708.00
PEF-PS-PTFE-500	484/500	500	19/26	19/26	850.00
PEF-PS-PTFE-500	484/500	500	24/29	24/29	860.00

04.488 Pressure Equalising Funnels, "SGCLABS", Cylindrical, with socket, Glass key/ PTFE Key stopcock, stem with cone.

Sap Code	Cat No.	Capacity ml.	Socket Size	Cone Size	Price/Piece.
PEF-C-PTFE-50	488/50	50	19/26	19/26	610.00
PEF-C-PTFE-100	488/100	100	19/26	19/26	630.00
PEF-C-PTFE-250	488/250	250	19/26	19/26	805.00
PEF-C-PTFE-250	488/250	250	24/29	24/29	815.00
PEF-C-PTFE-500	488/500	500	19/26	19/26	1050.00
PEF-C-PTFE-500	488/500	500	24/29	24/29	1060.00

ASSEMBLIES

05.490 A Distillation Apparatus, "SGCLABS", Consists of 500 ml. Flask, 200 mm. Graham condenser, and stopper 905.00

05.490 B Distillation Apparatus, "SGCLABS", Consists of 2000 ml. Flask, Friedrich condenser and stopper. 1730.00

05.490 C Distillation Apparatus, "SGCLABS", compact, Consists of 1000 ml. Erlenmeyer Flask, and Friedrich condenser. 1440.00

05.492 Distillation Apparatus Ammonia, "SGCLABS", Consists of 500 ml. Kjeldahl Flask, splash head and Graham condenser. 965.00

05.494 Distillation Assembly, "SGCLABS", consists of R.B. flask, splash head, double surface condenser and receiver adapter.

Sap Code	Cat No.	Flask Capacity ml.	Condenser effective length mm	Price/Piece.
DA-C-2000	494/2000	2000	200	1375.00
DA-C-3000	494/3000	3000	300	2795.00
DA-C-5000	494/5000	5000	400	4065.00
DA-C-10000	494/10000	10000	600	7700.00

05.496 Distillation Apparatus, "SGCLABS", consists of R.B. flask, recovery bend, Liebig condenser and receiver adapter

Sap Code	Cat No.	Flask Capacity ml.	Condenser effective length mm	Price/Piece.
DA-RB-250	496/250	250	200	520.00
DA-RB-500	496/500	500	300	625.00
DA-RB-1000	496/1000	1000	350	830.00
DA-RB-2000	496/2000	2000	400	1250.00

05.498 Kjeldahl Distillation Assembly, "SGCLABS", consists of Kjeldhal flask 500 ml., multiple adapter two necks, splash head verticle, Liebig condenser, receiver adapter and dropping funnel 100 ml.

1250.00

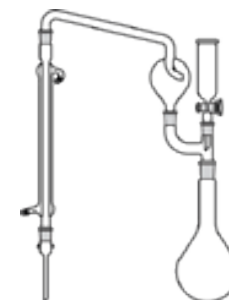

05.498

EXTRACTORS

05.500 Soxhlet Extraction, "SGCLABS", consists of Flask, Extractor and Condenser.

Sap Code	Cat No.	Extractor Capacity	Extractor Socket	Extractor Cone	Flask Capacity	Price/Piece.
SE-E-60	500/60	60	34/35	24/29	150	600.00
SE-E-100	500/100	100	40/38	24/29	250	690.00
SE-E-200	500/200	200	50/42	24/29	500	980.00

05.502 Spare Extractor, "SGCLABS", for Soxhlet. Cat No. 05.631.

Sap Code	Cat No.	Capacity	Socket	Cone	Price/Piece.
SE-S-60	502/60	60	34/35	24/29	256.00
SE-S-100	502/100	100	40/38	24/29	290.00
SE-S-200	502/200	200	50/42	24/29	435.00

05.504 Soxhlet Extraction, "SGCLABS", consists of R.B. Flask, Extractor with Flat flange, reduction adapter with flat flange and socket and double surface condenser.

Sap Code	Cat No.	Extractor Capacity ml.	Flask Capacity MI	Price/Piece.
SE-E-600	504/600	600	2000	3500.00
SE-E-1000	504/1000	1000	3000	6600.00
SE-E-2000	504/2000	2000	5000	9880.00
SE-E-3000	504/3000	3000	10000	13500.00

05.506 Moisture Determination Unit, "SGCLABS", (Dean & Stark), comprises of 1000ml round bottom flask, 10ml receiver and liebig condenser.



05.500



05.502



05.504

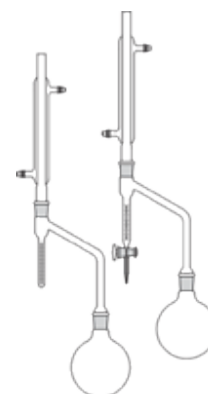

05.506

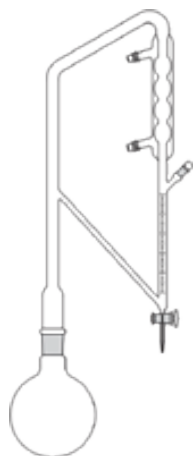

05.512



05.514 A

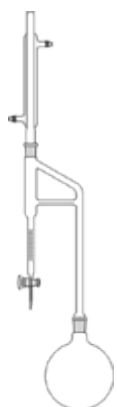

05.514 B

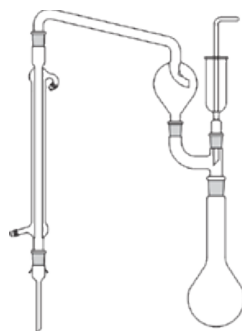

05.516

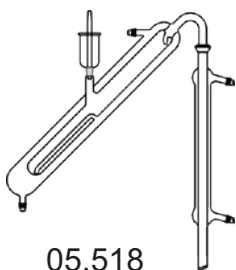

05.518



05.522

Sap Code	Cat No.	Capacity (ml)	Price/Piece.
MDU-DS-001	506/001	Receiver with stopcock	940.00
MDU-DS-002	506/002	Receiver without stopcock	870.00
MDU-DS-001	508/001	Spare receiver with stopcock	365.00
MDU-DS-S-002	508/002	Spare receiver without stopcock	300.00

05.512 Clevenger Assembly, "SGCLABS", for determination of volatile oil lighter than water, comprising of 1000 ml.

Sap Code	Cat No.	Flask Capacity ml.	Price/Piece.
CA-L-001	512/001	1000	1600.00

05.514 A Clevenger Assembly, "SGCLABS", for determination of volatile oil heavier than water, comprising of 1000 ml.

1175.00

05.514 B Clevenger Assembly, "SGCLABS", for determination of volatile oil heavier than water, comprising of 1000 ml.

1175.00

05.516 Macro Kjeldahl Distillation, "SGCLABS", Comprising of 500 ml Kjeldahl flask, multiple adapter, dropping funnel with plug, splash head, condenser and receiver adapter

1245.00

05.518 Markham Semi Micro Distillation Unit, "SGCLABS",

Sap Code	Cat No.	Description	Price/Piece.
MS-MD-001	518/001	Comprising of Markham still body with enclosed evaporator vessel in a combined steam jacket and trap, funnel plug, condenser and spherical joint clip.	1700.00
CS-SJ-001	520/001	Comprising similar parts but with conical joints instead of spherical joints.	1425.00

WATER DISTILLATIONS

05.522 "SGCLABS", Water Still comprises of a horizontal Borosilicate glass boiler fitted with a 3KW chromium plated immersion heater with cut off, double coil high efficiency condenser ensure a reliable output of single distillate. The still is fitted on a sheet metal epoxy coated stand, suitable for bench or wall mounting. For use on 220/240 V. 50/60 Hz single phase supply. As per picture. Distillate Output : 4 Liters/hr Approx, Ph : 5 to 6.5 Pyrogen free.

11600.00

Sap Code	Cat No.	Description	Price/Piece.
B-WS-001	524/001	Boiler For Water Still	3850.00
C-WS-001	526/001	Condenser For Water Still	3900.00
HT-KW-3	528/3	Heater 3KW Fitted With Thermostat	2800.00

Note: ph, conductivity and sensitivity are affected by temperature and the presence of absorbed carbon dioxide. The basis of tests are at 20° C on distilled water free of carbon dioxide. Care is needed to obtain Pyrogen free water and the distillate must be tested before use. Pre treated input water (use of softener) is recommended for obtaining better results and to increase the still lif.

05.530 "SGCLABS", Water Stills are carefully designed to produce high purity pyrogen free distilled water. The water still of borosilicate glass comprises of horizontal type boiler, coil condenser, constant level device, Silica sheathed heaters, along with stand and clamps. All parts are replaceable.

Sap Code	Cat No.	Description	Price/Piece.
SS-O-1.5	530/1.5	Single Still Without Cut Off, Output 1.5 Lt./Hr. Approx.	8100.00
SS-TS-O-1.5	532/1.5	Single Still With Thermal Sensor Auto Cut Off, Output 1.5 Lt./Hr.	12200.00
DS-O-1.5	534/1.5	Double Still Without Cut Off, Output 1.5 Lt./Hr.Approx.	15500.00
DS-TS-A-1.5	536/1.5	Double Still With Thermal Sensor Auto Cut Off,Output 1.5 Lt./Hr.	19200.00
TS-A-3538/3		Single Still With Thermal Senso Auto Cut Off,Output 3 Lt./Hr.	19600.00
DS-TS-A-3	540/3	Double Still With Thermal Sensor Auto Cut Off,Output 3 Lt./Hr.	38000.00
CLD-WS-001	542/001	Constant Level Device	400.00
BC-S-1.5	544/1.5	Boiling Chamber For 1.5 Lt./Hr. Still	2100.00
BC-S-3	544/3	Boiling Chamber For 3 Lt./Hr. Still	3350.00
CC-S-1.5	546/1.5	Coil Condenser For 1.5 Lt./Hr. Still	1550.00
CC-S-3	546/3	Coil Condenser For 3 Lt./Hr. Still	3100.00
ST-SH-B-001	548/001	Silica Tube Sheathed Heater 1.25 KW With Bakelite Cap	2400.00
ATS-SS-001	550/001	Automatic Thermal Sensor Cut Off For Single Still	4400.00
ATS-DS-001	552/001	— Do — For Double Still	5000.00
WS-S-001	554/001	Water Softner Suitable For Above Stills	7600.00
RO-USP-5	556/5	Reverse Osmosis Unit 5 Stage Purification (For Removal Of 80-90%	24000.00

Salts). Recommended Where The Salts
Are More In Raw Water.

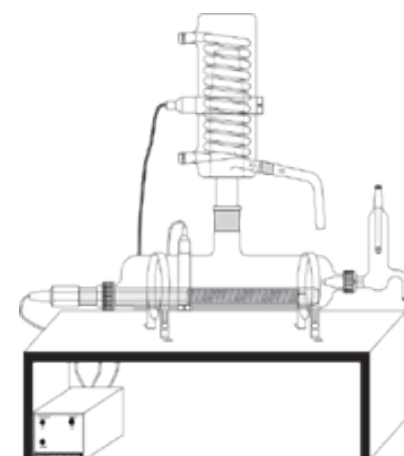

05.530

Note: Automatic cut off offered above have been newly designed. Two sensitive thermal sensors are provided (one at boiling chamber and the second t condenser body) so no outside electrodes are needed. It is more sturdy and reliable as compared to the conventional type.

05.558 Heat Exchanger for Water Distillations and Stills Hot water from the condenser outlet is cooled and recirculated in the condenser, thus savings the water wastage. Power consumption 375 watts.) 54000.00

05.560 "SGCLABS", All glass Distillation Unit N.P.L. Design, with heater embedded in spiral glass tube complete with C.I. heavy base, SS Rod, Clamps, Board etc.



05.560

Sap Code	Cat No.	Flask Capacity (ml)	Description (ml)	Price/Piece.
AGD-SD-3	560/3	3 Litre	Single Distillation Without Cut Off	8700.00
AGD-SD-TS-3	562/3	3 Litre	Single Distillation With Thermal Sensor Auto Cut Off	12925.00
AGD-SD-5	564/5	5 Litre	Single Distillation Without Cut Off	9870.00
AGD-SD-TS-5	566/5	5 Litre	Single Distillation With Thermal Sensor Auto Cut Off	14100.00
AGD-SD-10	568/10	10 Litre	Single Distillation Without Cut Off	14310.00
AGD-SD-TS-10	570/10	10 Litre	Single Distillation With Thermal Sensor Auto Cut Off	18540.00
AGD-DD-3	572/3	3 Litre	Double Distillation Without Cut Off	17400.00
AGD-DD-TS-3	574/3	3 Litre	Double Distillation With Thermal Sensor Auto Cut Off	22200.00
AGD-DD-5	576/5	5 Litre	Double Distillation Without Cut Off	19750.00
AGD-DD-TS-5	578/5	5 Litre	Double Distillation With Thermal Sensor Auto Cut Off	26400.00
AGD-DD-10	580/10	10 Litre	Double Distillation Without Cut Off	28625.00

Sap Code	Cat No.	Flask Capacity (ml)	Description (ml)	Price/Piece.
AGD-DD-TS-10	582/10	10 Litre	Double Distillation With Thermal Sensor Auto Cut Off	33420.00
AGD-TD-3	584/3	3 Litre	Triple Distillation Without Cut Off	26100.00
AGD-TD-TS-3	586/3	3 Litre	Triple Distillation With Thermal Sensor Auto Cut Off	31100.00
AGD-TD-5	588/5	5 Litre	Triple Distillation W/O Cut Off	29600.00
AGD-TD-TS-5	590/5	5 Litre	Triple Distillation With Thermal Sensor Auto Cut Off	34625.00
AGD-TD-10	592/10	10 Litre	Triple Distillation Without Cut Off	42950.00
AGD-TD-TS-10	594/10	10 Litre	Triple Distillation With Thermal Sensor Auto Cut Off	48200.00
Spares Parts :				
FH-3	596/3		Flask With Heater 3 Litre	5100.00
FH-5	596/5		Flask With Heater 5 Litre	6300.00
FH-10	596/10		Flask With Heater 10 Litre	10750.00
DC-3	598/3		Condenser For 3 Litre Distillation With 40/38 Cone	1400.00
DC-5598/5			Condenser For 5 Litre Distillation With 40/38 Cone	1400.00
DC-10598/10			Condenser For 10 Litre Distillation With 50/42 Cone	1740.00
ATS-SD-001	600/001		Automatic Thermal Sensor Cut Off For Single Distillation	4400.00
ATS-DD-002	600/002		— Do — For Double Distillation	5000.00
ATS-TD-003	600/003		— Do — For Triple Distillation	5150.00
RT-C-001	602/001		Receiving Tube For Condenser	380.00
SD-S-001	604/001		Stand For Single Distillation For 3, 5 Or 10 Liters Flask	2000.00
SD-D-001	606/001		Stand For Double Distillation	4000.00
WS-D-001	608/001		Water Softener Suitable For Above Distillations	7600.00
RO-USP-001	610/001		Reverse Osmosis Unit 5 Stage Purification (For Removal Of 80 – 90% Salts) Recommended Where	24000.00

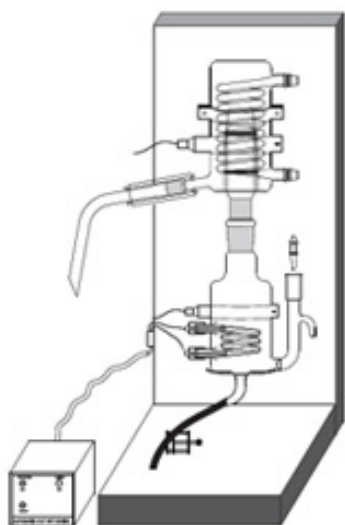

05.612

Note: Installation Charges for Distillations at extra cost.

05.612 "SGCLABS", Water Distillation Unit comprising Quartz Boiler with inbuilt heater and Coil Condensers, Complete with Stand, Clamps etc. Conductivity of Distilled water produced is less than 1u S cm-1, pH 6-7, suitable for HPLC.

Sap Code	Cat No.	Description	Price/Piece.
WDU-QB-BG-2	612/2	With Quartz Boiler, Borosilicate Condenser, Output approx.2 ltr. / hr	24000.00
WDU-QB-QC-2	614/2	With Quartz Boiler, Quartz Condenser, output approx.2 ltr. / hr	38800.00
WDU-QB-BGTS-2	616/2	With Quartz Boiler, Quartz Condenser	28400.00
WDU-QB-QCTS-2	618/2	output approx.2 ltr. / hr., fitted with Auto Thermal Sensor Cut off with Quartz Boiler, Quartz Condensers, out put approx. 2ltr. / hr., fitted with Auto Thermal Sensor Cut off	43200.00
WDU-QB-BG-5	620/5	With Quartz Boiler, Borosilicate Condenser, out put approx. 2ltr. / hr.	38000.00
WDU-QB-QC-5	622/5	With Quartz Boiler, Quartz Condenser, output approx.5 ltr. / hr	75000.00
WDU-QB-BGTS-5	624/5	With Quartz Boiler, Borosilicate Condenser, out put approx. 5ltr. / hr., fitted with Auto Thermal Sensor Cut off	42400.00
WDU-QB-QCTS-5	626/5	With Quartz Boiler, Quartz Condenser, output approx.5 ltr. / hr., fitted with Auto Thermal Sensor Cut off	79400.00

Water Distillation Unit Spares

628/2	Quartz Boiler for 2 Lt./Hr. Dist.	17000.00
628/5	Quartz Boiler for 5 Lt./Hr. Dist.	26750.00
630/2	Borosilicate Condenser for 2 Lt./Hr. Dist.	2800.00
630/5	Borosilicate Condenser for 5 Lt./Hr. Dist..	3900.00
632/2	Quartz Condenser for 2 Lt./Hr. Distillation	22250.00
632/5	Quartz Condenser for 5 Lt./Hr. Distillation	49000.00

05.634 "SGCLABS", All Quartz Double Distillation.

Sap Code	Cat No.	Description	Price/Piece.
AQ-DD-1.5	634/1.5	All Quartz Double Distillation With Auto Cut Off,Out Put	65000.00
Approx 1.5 Lt./Hr.			
AQ-DD-2.5	636/2.5	All Quartz Double Distillation With Auto Cut Off,Out Put	87000.00
Approx 2.5 Lt./Hr.			
WS-D-002	638/002	Water Softner Suitable For Above Distillations	7600.00
RO-USP-002	640/002	Reverse Osmosis Unit 5 Stage Purification (For Removal Of 80-90% Salts).Recommended Where The Salts Are More In Raw Water.	24000.00



05.634

Note : It is hereby strongly recommended that while placing order for Cat. No 05.685 (OR) 05.691. Water Still/Distillations, the order for softener may be placed, to increase the quality of input water, to avoid silting in the boiling chambers, thus increasing the efficiency, quality as well as life of the units. Installation Charges for 05.685 and 05.691 are at extra cost.

SINTERED GLASSWARE (Filtration)

Porosity Grade	Pore Size	General
G-0	150-250	Coarse Filtration, Gas dispersion and Support for other filter material.
G-1	90-150	Coarse Precipitate, Filtration, Gas Dispersion, Coarse grain Material filtration.
G-2	40-90	Medium & Crystalline precipitate filtration, medium filtration & Washing of gases.
G-3	15-40	Fine Gas filtration and dispersion, mercury filtration, precipitates. Analytical Work with medium precipitates.
G-4	5/15	"Valves for mercury collection of very fine Precipitates .Analytical work with finePrecipitate"

06.642 Crucible, "SGCLABS", Gooch type with Sintered Disc of Porosity G-1 or G-2 or G-3 or G-4.

Sap Code	Cat No.	Capacity ml.	Price/Piece.
CGT-STG1-15	642/15	15	70.00
CGT-STG1-30	642/30	30	78.00
CGT-STG1-50	642/50	50	150.00

Note: Please mention Porosity of Sintered Disc, while placing order.

06.650 Adapter, "SGCLABS", for Gooch Crucible

Sap Code	Cat No.	LD x Ht. mm.	Stem mm.	Suitable for Crucible ml.	Price/Piece.
AGC-15	650/15	31 X 60	75 X 9	15	51.00
AGC-30	650/30	40 X 68	75 X 9	30	55.00
AGC-50	650/50	47 X 78	75 X 9	50	78.00

06.652 Buchner Funnel, "SGCLABS", with Sintered Disc of Porosity G-1 or G-2 or G-3 or G-4, plain stem.

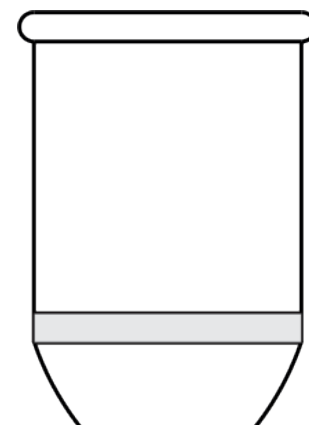

06.642



06.650



06.652

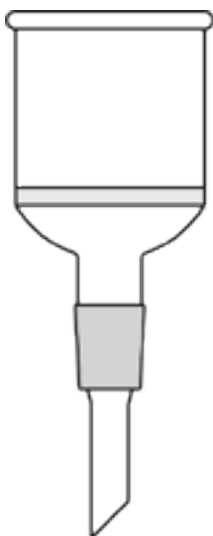

06.654



06.668



06.682

Sap Code	Cat No.	Capacity ml.	Disc Dia mm	Price/Piece.
BF-PSG1-35	652/35	35	30	148.00
BF-PSG1-80	652/80	80	40	240.00
BF-PSG1-200	652/200	200	65	520.00
BF-PSG1-500	652/500	500	90	1395.00
BF-PSG1-1000	652/1000	1000	120	2975.00
BF-PSG1-2000	652/2000	2000	145	6450.00

Note: Please mention the Porosity while placing your order.

06.654 Buchner Funnel, "SGCLABS", with Sintered Disc of Porosity G-1 or G-2 or G-3 or G-4, cone at stem.

Sap Code	Cat No.	Capacity	Disc Dia mm.	Cone	Price/Piece.
BF-PSG2-35	654/35	35	30	14/23 Or 19/26	225.00
BF-PSG2-80	654/80	80	40	14/23 Or 19/26	330.00
BF-PSG2-200	654/200	200	65	19/26 Or 24/29	675.00
BF-PSG2-500	654/500	500	90	24/29 Or 29/32	1720.00
BF-PSG2-1000	654/1000	1000	120	24/29 Or 29/32	4200.00
BF-PSG2-2000	654/2000	2000	145	24/29 Or 29/32	7900.00

Note: Please mention Porosity of Sintered Disc and cone size, while placing order. Other sizes of cones can also be fitted at stem, on same prices.

06.668 Filter Apparatus, "SGCLABS", Complete with Filtering Flask, gooch crucible with Sintered Disc of Porosity G-1 or G-2 or G-3 or G-4, glass adapter and rubber cone and rubber cone.

Sap Code	Cat No.	Flask Capacity	Crucible Capacity	Price/Piece.
FA-CFF-1-250	668/250	250	30	390.00
FA-CFF-1-500	668/500	500	30	475.00
FA-CFF-1-1000	668/1000	1000	50	735.00

Note: Please mention Porosity of Sintered Disc, while placing order.

06.682 Filter Apparatus, "SGCLABS", Complete, Filter Flask with Socket and Buchner funnel with Sintered Disc of Porosity G-1 or G-2 or G-3 or G-4, having cone at stem.

Sap Code	Cat No.	Flask Capacity (ml)	Crucible Capacity (ml)	Joint	Price/Piece.
FA-FFS-4-250	682/250	250	80	24/29	595.00
FA-FFS-4-500	682/500	500	200	24/29	1005.00
FA-FFS-4-1000	682/1000	1000	500	29/32	2300.00
FA-FFS-4-2000	682/2000	2000	1000	29/32	5625.00

Note : Please mention Porosity of Sintered Disc, while placing order.

06.684 Filtering Apparatus Witt's, "SGCLABS", Complete with flanged jar, flanged lid, funnel and 250 ml. Beaker. 2500.00

06.686 Membrane Filter Holder Assembly, "SGCLABS", with support for membrane, Funnel, Flask and Clamp, Standard Joint Fitting.

Sap Code	Cat No.	Membrane dia mm	Funnel Capacity (ml)	Flask Capacity (ml)	Price/Piece.
MF-HA-SJ-250	686/250	13	35	250	1640.00
MF-HA-SJ-500	686/500	25	35	500	1740.00
MF-HA-SJ-1000	686/1000	47	300	1000	3000.00
MF-HA-SJ-2000	686/2000	47	300	2000	3450.00
MF-HA-SJ-5000	686/5000	47	300	5000	5250.00

06.688 Membrane Filter Holder Assembly, "SGCLABS", with support for membrane, Funnel, Flask and Clamp, Neoperene Rubber Cork fitting.

Sap Code	Cat No.	Membrane dia mm	Funnel Capacity (ml)	Flask Capacity (ml)	Price/Piece.
MF-HA-RC-250	688/250	13	35	250	1485.00
MF-HA-RC-500	688/500	25	35	500	1650.00
MF-HA-RC-1000	688/1000	47	300	1000	2850.00
MF-HA-RC-2000	688/2000	47	300	2000	3150.00
MF-HA-RC-5000	688/5000	47	300	5000	4850.00

06.690 Filter Holders, Stainless Steel, Best Quality (To hold Membrane Filters)

Sap Code	Cat No.	Description	Price/Piece.
FH-SS-SFH-13	690/13	Syringe Filter Holder For 13 Mm Membrane	675.00
FH-SS-SFH-25	690/25	Syringe Filter Holder For 25 Mm Membrane	1050.00
VFH-47	692/47	Vacuum Filter Holder	4400.00
For 47 Mm W/O Flask			
3BST-M-47	694/47	3 Branch Sterility Test, For 47 Mm, Membrane	31500.00
6BST-M-47	696/47	6 Branch Sterility Test, For 47 Mm, Membrane	63000.00

06.698 Oil Free Portable Vacuum Pumps (Diaphragm Type)

Sap Code	Cat No.	Max. Flow (its min./in Hg)	Max. Vaccum	Motor HP	Price/Piece.
OFP-VP-120	698/120	15	22"	1/20	7500.00
OFP-VP-116	698/116	25	27"	1/16	9200.00
OFP-VP-18	698/18	45	22"	1/8	10900.00
OFP-VP-14	698/14	75	22"	1/4	13950.00

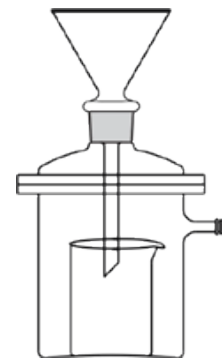

06.684

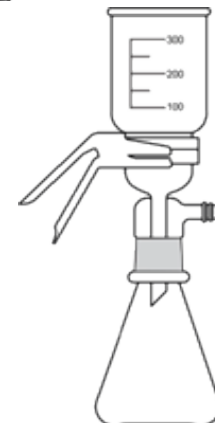

06.686

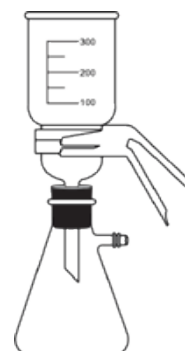

06.688

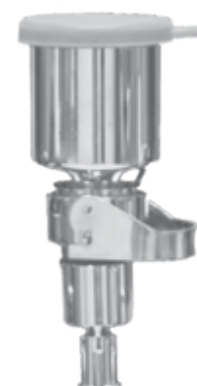

06.690.13



06.698

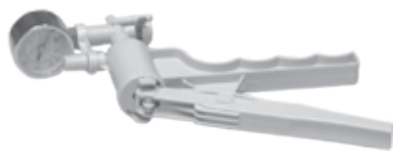

06.700

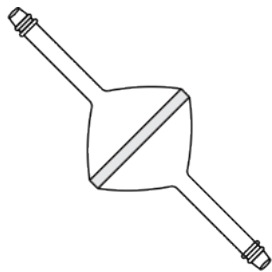

06.702

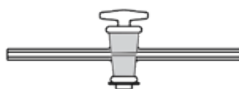
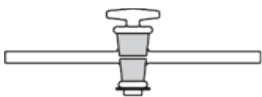

07.710

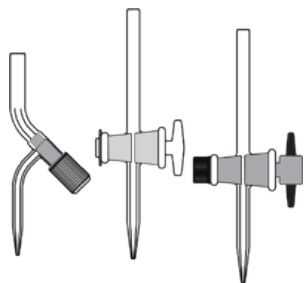

07.718

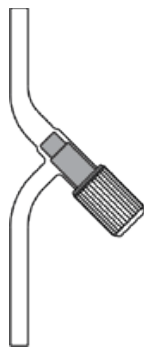

07.722

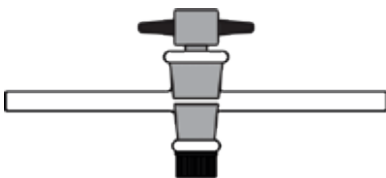

07.724

06.700 Hand Vacuum Pump Plastic, with Gauge. 2500.00

06.702 Tube Sealed, "SGCLABS", with reduced ends, with Sintered Disc (Pipe line filter) Porosity G-1 or G-2 or G-3 or G-4.

Sap Code	Cat No.	Disc Dia mm.	Price/Piece.
TS-SD-1-30	702/30	30	225.00
TS-SD-1-40	702/40	40	450.00
TS-SD-1-50	702/50	50	600.00
TS-SD-1-65	702/65	65	810.00
TS-SD-1-90	702/90	90	1800.00

Note : Please mention Porosity of Sintered Disc, while placing order.

STOPCOCKS

07.710 Stopcock, "SGCLABS", Straight Bore.

Sap Code	Cat No.	Description	Price/Piece.
SC-SB-ST-1.2	710/1.2	With Solid Plug, Side Tube	90.00
SC-SB-CT-1.2	712/1.2	With Solid Plug, Side Capillary	104.00

07.718 Stopcock, "SGCLABS", for Burettes.

Sap Code	Cat No.	Description	Price/Piece.
SC-BU-SGK-001	718/001	With Solid Glass Key	60.00
SC-BU-PTFE-002	718/002	With PTFE Key	260.00
SC-BU-RF-003	720/003	With PTFE Needle. Screw type	58.00

07.722 Stopcock "SGCLABS", Screw type PTFE, needle with Two Plain limbs.

Sap Code	Cat No.	Limbs O.D. (mm)	Price/Piece.
SC-RF-2PL-8	722/8	8	66.00
SC-RF-2PL-10	722/10	10	148.00
SC-RF-2PL-12	722/12	12	210.00
SC-RF-2PL-15	722/15	15	275.00

07.724 Stopcock, "SGCLABS", Straight Bore with PTFE key.

Sap Code	Cat No.	Body Wide End I.D. mm. Approx.	Key Bore (mm)	Price/Piece.
SC-SB-PTFE-1	724/1	10	1	275.00
SC-SB-PTFE-2	724/2	12	2	275.00
SC-SB-PTFE-3	724/3	14	3	330.00
SC-SB-PTFE-4	724/4	16	4	450.00
SC-SB-PTFE-6	724/6	19	6	685.00
SC-SB-PTFE-8	724/8	24	8	1240.00

CLINICAL LAB. GLASSWARE

08.726 Graduated Micro Capillary Pipettes, Disposable, calibrated "to contain"

Sap Code	Cat No.	Capacity (ml)	Graduation (ml.)	Colour Code	Price/Piece.
MCP-G-5	726/5	05	1,2,3,4,5	White	565.00
MCP-G-5	728/5	05	5	White	520.00
MCP-G-5	730/10	10	10	Orange	520.00
MCP-G-5	732/10	10	5 & 10	Orange	565.00
MCP-G-5	734/20	20	10 & 20	Black	520.00
MCP-G-5	736/20	20	20	Black	520.00
MCP-G-5	738/25	25	25	White	520.00
MCP-G-5	738/44	44	44.7	Purple	635.00
MCP-G-5	738/50	50	50	Green	520.00
MCP-G-5	738/100	100	100	Blue	520.00
MCP-G-5	738/200	200	200	Red	635.00



08.726



08.740

08.740 Haematocrit Capillaries, colour Blue for Non Hepernised and Red for hepernised.

Sap Code	Cat No.	Description	Price/Piece.
HC-NHB-75	740/75	75 mm non herpeernised capillary (100/vial)	58.00
HC-HB-75	742/75	75 mm herpeernised capillary (100/vial)	84.00

08.744 Micro Slide: 75 x 25mm Prepared from high quality thin glass, 1.00-1.2mm thick, packed with Paper in between each slide and sealed in transparent PP Envelope, Pk. of 50.

Sap Code	Cat No.	Type	Price/Piece.
MS-GE-001	744/001	Ground Edges	61.00
MS-GE-19	744/19	Ground Edges & one side at one end 19 mm frosted Surface	74.00



08.744



08.767

08.746 Micro Slide : 75 x 25mm Prepared from high quality thin glass, 1.35 mm thick, Pk. of 50.

Sap Code	Cat No.	Type	Price/Piece.
MS-GE-0001	746/0001	Ground Edges	46.00
MS-GE-019	746/019	Ground Edges & one side at one end 19 mm frosted Surface	59.00



08.769

08.748 Micro Concavity Slides: 75x75x1.45mm, spherical concavities are 15-18mm dia 0.5 to 0.6mm deep, beveled and polished edges, Pk. of 10.



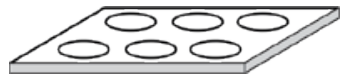

08.752-001

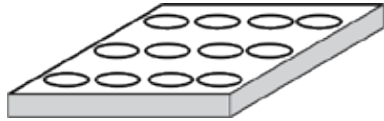

08.754-100



08.756



08.762



08.768

Sap Code	Cat No.	No. of Concavities	Price/Piece.
MS-GE-1	748/1	One	60.00
MS-GE-1	748/2	Two	66.00
MS-GE-1	748/3	Three	72.00
MS-GE-BSS-1	750/1	Blood Smear slides	74.00

08.752-001 V.D.R.L. Slides (Kline Concavity Slides): 75x56x3mm, Concavities 16mm. Dia. 1.75mm. deep, Polished edges, Frosted surface. 12 concavities 67.00

08.754-100 Blood Grouping Slides: 100 x 100 x 10mm thick, 12 concavities of 21mm Dia x 1.5mm deep, frosted surface(One slide) 205.00

08.756 Cover Glasses No.1 (Thickness 0.13 to 0.17mm), Pk. of 10 gm, imported glass.

Sap Code	Cat No.	Size mm	Size mm.	Price/Piece.
CG-SS-1818	756/18	Square	18 X 18	62.00
CG-SS-2222	756/22	Square	22 X 22	62.00
CG-SS-2424	756/24	Square	24 X 24	62.00
CG-RS-2240	758/2240	Rectangular	22 X 40	90.00
CG-RS-2250	758/2250	Rectangular	22 X 50	90.00
CG-RS-2450	758/2450	Rectangular	24 X 50	90.00
CG-RS-2460	758/2460	Rectangular	24 X 60	93.00
CG-HS-22	760/22	Haemocytometer	22 X 25 X 0.4mm (10 Pairs)	92.00

08.762 Haemocytometer in box with counting chamber. Cover glasses pair, R.B.C. and W.B.C Pipettes with rubber suction tubing and month piece.

Sap Code	Cat No.	Description	Price/Piece.
HB-SL-001	762/001	with Silver line Counting Chamber	2000.00
HB-BL-002	762/002	with Bright line, Imported Counting Chamber	1600.00
HB-CBL-002	764/002	Counting Chamber, Brightline, imported	1350.00
RBC-P-001	766/001	R.B.C. Pipette	600.00
WBC-P-002	766/002	W.B.C. Pipette	125.00

08.768 Haemometer

Sap Code	Cat No.	Description	Price/Piece.
HCS-001	768/001	Haemometer Complete Set	780.00
HT-001	770/001	Haemometer Tube	445.00
- HP-20	772/20	Haemometer Pipette 20µl	65.00

TISSUE HOMOGENISERS

08.774 Teflon Pestle Tissue Homogenisers, "SGCLABS", having stainless steel rod, replaceable vessel of Borosilicate glass for the preparation of tissue homogenates.

Sap Code	Cat No.	Capacity ml.	Price/Piece.
TP-TH-5	774/5	5	375.00
TP-TH-10	774/10	10	395.00
TP-TH-30	774/30	30	435.00
TP-TH-50	774/50	50	560.00
TP-TH-100	774/100	100	805.00

08.776 Spare Glass Vessel, "SGCLABS", for Cat. No. 08.774

Sap Code	Cat No.	Capacity ml.	Price/Piece.
SG-V-5	776/5	5	175.00
SG-V-10	776/10	10	180.00
SG-V-30	776/30	30	210.00
SG-V-50	776/50	50	255.00
SG-V-100	776/100	100	310.00

GAS ANALYSIS

09.778 Impinger, "SGCLABS", graduated, for sampling small gas volumes as per standard specification.

Sap Code	Cat No.	Capacity ml.	Price/Piece.
IM-G-35	778/35	35	140.00

09.780 Calcium Chloride Tube, "SGCLABS", Straight or bent.

Sap Code	Cat No.	Capacity ml.	Price/Piece.
CCT-SB-1	780/1	With One Bulb	26.00
CCT-SB-2	780/2	With Two Bulbs	30.00

09.782 Calcium Chloride Tube, "SGCLABS", U shape.

Sap Code	Cat No.	Ht.x Tube O.D. mm. (approx.)	Price/Piece.
CCT-US-100	782/100	100 X 12	40.00
CCT-US-125	782/125	125 X 15	57.00
CCT-US-150	782/150	150 X 18	78.00

09.784 Calcium Chloride Tube, U Shape with side tube

Sap Code	Cat No.	Ht.x Tube O.D. mm. (approx.)	Price/Piece.
CCT-US-ST-100	784/100	100 X 12	55.00
CCT-US-ST-125	784/125	125 X 15	78.00
CCT-US-ST-150	784/150	150 X 18	99.00



08.774



08.776

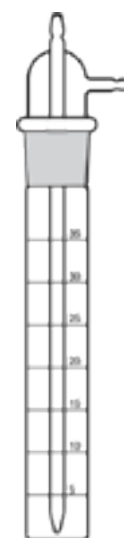

09.778



09.780

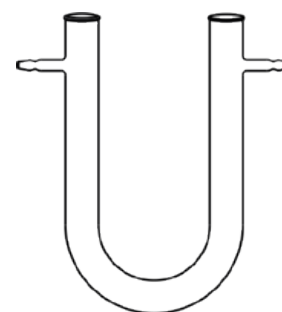

09.784

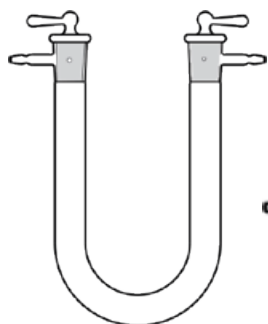

09.786



09.788



09.790



09.792



09.794



09.796

09.786 Calcium Chloride Tube, "SGCLABS", U shape with side tube and interchangeable stopper.

Sap Code	Cat No.	Ht.x Tube O.D. mm. (approx.)	Price/Piece.
CCT-US-STS-100	786/100	100 X 12	165.00
CCT-US-STS-125	786/125	125 X 15	174.00
CCT-US-STS-150	786/150	150 X 18	180.00

09.788 Calcium Chloride Tower, "SGCLABS", Tubular at bottom and stopcock at top.

Sap Code	Cat No.	Body O.D. x Ht. mm. (approx.)	Price/Piece.
CCT-TB-38	788/38	38 X 250	585.00
CCT-TB-50	788/50	50 X 300	740.00
CCT-TB-60	788/60	60 X 300	1100.00

09.790 Gas Collecting Tubes, "SGCLABS", with two three way double oblique bore stopcocks one on each side.

Sap Code	Cat No.	Capacity ml.	Price/Piece.
GCT-SC-100	790/100	100	350.00
GCT-SC-250	790/250	250	450.00
GCT-SC-500	790/500	500	700.00

09.792 Gas Collecting Tubes, "SGCLABS", with two three way double oblique bore, PTFE key stopcocks one on each side.

Sap Code	Cat No.	Capacity ml.	Price/Piece.
GCT-PTFE-100	792/100	100	900.00
GCT-PTFE-250	792/250	250	975.00
GCT-PTFE-500	792/500	500	1080.00

09.794 Gas Collecting Tubes, "SGCLABS", with two, two way Glass Key stopcocks one on each side.

Sap Code	Cat No.	Capacity ml.	Price/Piece.
GCT-2WGK-125	794/125	125	300.00
GCT-2WGK-250	794/250	250	400.00
GCT-2WGK-500	794/500	500	550.00

09.796 Gas Collecting Tubes, "SGCLABS", with two, two way PTFE Key stopcocks one on each side.

Sap Code	Cat No.	Capacity ml.	Price/Piece.
GCT-2WPTEFE-125	796/125	125	600.00
GCT-2WPTEFE-250	796/250	250	700.00
GCT-2WPTEFE-500	796/500	500	880.00

09.798 Gas Washing Bottles, "SGCLABS", Dreshle's type, interchangeable joints.

Sap Code	Cat No.	Capacity ml.	Price/Piece.
GCT-DT-125	798/125	125	400.00
GCT-DT-125	798/250	250	480.00
GCT-DT-125	798/500	500	610.00

09.800 Spare Head, for above gas wash bottles.(Please mention Bottle Cap)

195.00

09.802 Gas Washing Bottles, "SGCLABS", with sintered disc, interchangeable joints.

Sap Code	Cat No.	Capacity ml.	Price/Piece.
GWB-SD-125	802/125	125	590.00
GWB-SD-250	802/250	250	690.00
GWB-SD-500	802/500	500	760.00

09.804 Spare Head, for above gas wash bottles.(Please mention Bottle Cap)

360.00

09.806 Gas Jar, "SGCLABS", with ground Glass flat flange.

Sap Code	Cat No.	Height mm (approx)	O.D. mm (approx)	Price/Piece.
GJ-GG-FF-001	806/001	150	50	295.00
GJ-GG-FF-002	806/002	200	50	340.00
GJ-GG-FF-003	806/003	200	75	630.00
GJ-GG-FF-004	806/004	300	75	785.00

09.808 Gas Generator - Kipp's, "SGCLABS", with interchangeable joints.

Sap Code	Cat No.	Capacity ml.	Price/Piece.
GG-K-250	808/250	250	1800.00
GG-K-500	808/500	500	2250.00
GG-K-1000	808/1000	1000	2500.00

MISC. GLASSWARE

10.810 Dropping Bottle, Soda glass, polythene stopper with dust proof head, glass dropper and rubber teat.

Sap Code	Cat No.	Capacity ml.	Price/Piece.
DB-SG-30	810/30	30	58.00
DB-SG-60	810/60	60	59.00
DB-SG-120	810/120	120	62.00

10.812 Dropping Bottle, Soda glass, Amber color Polythene stopper with dust proof head, glass dropper and rubber teat.

Sap Code	Cat No.	Capacity ml.	Price/Piece.
DB-SGA-30	812/30	30	78.00
DB-SGA-60	812/60	60	78.00
DB-SGA-120	812/120	120	85.00

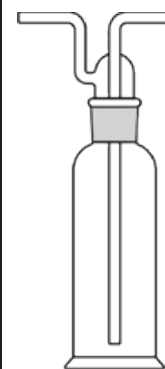

09.798

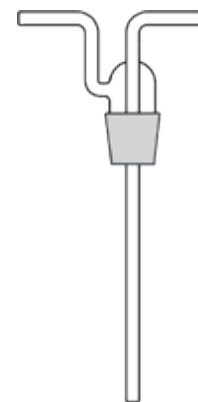

09.800

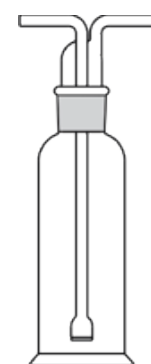

09.802

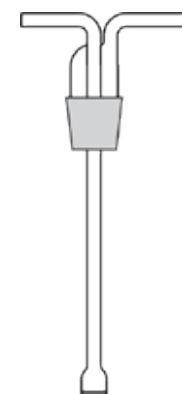

09.804



09.806

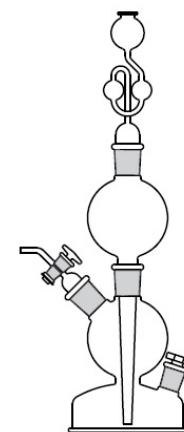

09.808

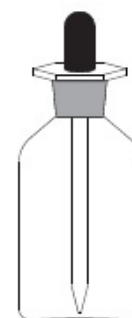

10.810

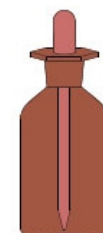

10.812

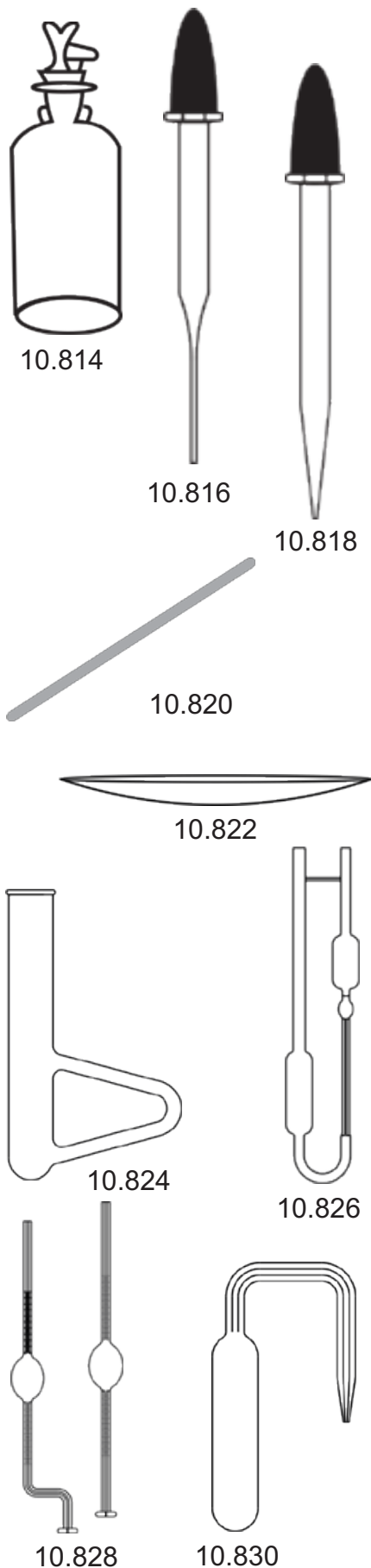
10.814 Dropping Bottle, T.K. Pattern Soda glass with grooved stopper.

Sap Code	Cat No.	Capacity ml.	Price/Piece.
DB-TK-30	814/30	30	65.00
DB-TK-60	814/60	60	78.00
DB-TK-120	814/120	120	90.00

10.816 Dropper, with capillary jet and rubber teat.

Sap Code	Cat No.	Description	Price/Piece.
DCJ-RT-5	816/5	5 Cm. With 5 Cm. Jet	12.00
DCJ-RT-8	816/8	8 Cm. With 10 Cm. Jet	14.00

10.818 Dropper, with rubber teat 15 cm.

12.00

10.820 Watch Glass

Sap Code	Cat No.	Dia mm.	Price/Piece.
WG-50	820/50	50	6.00
WG-62	820/62	62	7.00
WG-75	820/75	75	8.50
WG-100	820/100	100	18.00

10.822 Stirring Rod, glass

Sap Code	Cat No.	Dia. x Length mm.	Price/Piece.
SR-G-6150	822/6150	6 X 150	8.00
SR-G-6200	822/6200	6 X 200	10.00
SR-G-8200	822/8200	8 X 200	14.50
SR-G-8250	822/8250	8 X 250	16.00

10.824 Thiele's Melting Point Tubes, "SGCLABS",

Sap Code	Cat No.	Dia. x Length mm.	Price/Piece.
TM-PT-18	824/18	150 X 18	55.00
TM-PT-18	824/25	150 X 25	60.00

10.826 Viscometer, "SGCLABS", Ostwald, standard size, College Pattern, Centre support.

Sap Code	Cat No.	Size mm	Price/Piece.
VS-O-60	826/60	60-80 Sec.	80.00
VS-O-80	826/80	80-100 Sec.	102.00
VS-O-100	826/100	100-120 Sec.	102.00

10.828 Stalغانometer, "SGCLABS", Straight / Bent, graduated 165.00
10.830 Pycnometers, "SGCLABS",

Sap Code	Cat No.	Capacity ml.	Price/Piece.
PY-M-5	830/5	5	45.00
PY-M-10	830/10	10	48.00
PY-M-25	830/25	25	78.00

10.832 Filter Tubes, "SGCLABS", with side tube.

Sap Code	Cat No.	Tube Size mm.	Price/Piece.
FT-ST-001	832/001	100 X 12	21.00
FT-ST-002	832/002	125 X 15	22.00
FT-ST-003	832/003	150 X 18	27.00
FT-ST-004	832/004	150 X 25	34.00

10.834 Filter Pump, "SGCLABS",

Sap Code	Cat No.	Description	Price/Piece.
FP-UP-001	834/001	University Pattern.	78.00
FP-ET-HP-001	836/001	Edward's Type Heavy Pattern, Brass.	450.00

10.838-001 Dissolution Bowl, Clear, "SGCLABS", 1500.00

10.838-002 Dissolution Bowl, AMBER, "SGCLABS", 2100.00

10.840 Sampling Tube(Dip Tube) Sampling Tube(Dip Tube)1 meter long, Dia 19mm, Heavy wall 350.00

10.842 Schoinger Micro Combustion Flask Schoinger Micro Combustion Flask, "SGCLABS", (Oxygen Flask) with Platinum wire gauge sample carrier, for determination of Halogens, Sulphur, Phosphorus metal, etc. 11500.00

10.844 Hoffman's Voltmeter, "SGCLABS", to demonstrate that H₂O consists of two volumes of Hydrogen and one volume of Oxygen, with two 50 ml. Graduated limbs with stopcocks, central limb with reservoir and removable platinum electrodes.

Sap Code	Cat No.	Description	Price/Piece.
HV-SC-001	844/001	Complete Set Without Stand And Clamps	650.00
HV-PE-001	846/001	Spare Platinum Electrodes (Pair)	130.00
HV-CE-001	848/001	Spare Carbon Electrodes (Pair)	48.00
	850/002	Stand & Clamp For Above	650.00

10.852-05 Conductivity Cell Conductivity Cell, "SGCLABS", Dip type with two rectangular electrodes parallel in a vertical plane, with 0.5 cell constant. 1000.00

10.852-10 Conductivity Cell Same as Cat. No. 10.887, but with 1.0 cell constant. 950.00

10.854 pH Meter combined electrode, glass 900.00

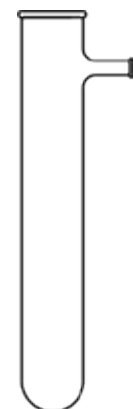

10.832

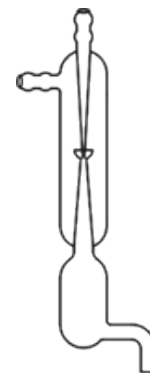

10.834

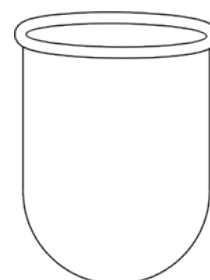

10.838-001



10.840

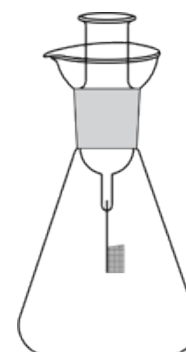

10.842

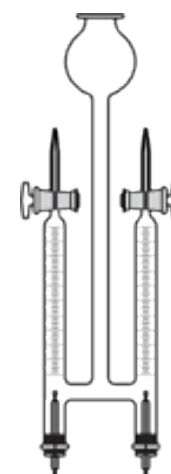

10.844



10.852.05

DAIRY & MILK TESTING APP

10.856 Butyrometer with plain neck 10% Dr. Gerber's Design. 47.00

10.856 Butyrometer ISI marked. 49.00

10.858 Butyrometer Butter Grade 0-100% or 0-90% or 0 80% with cup and rubber stopper, weighing type. 190.00

10.860-001 Butyrometer Cream 0-70% weighing type as per ISI specifications. 190.00

10.860-002 Butyrometer Cream 0-70% Volumetric Method, as per ISI specifications. 125.00

10.862 Butyrometer Skim Milk 0-0.5% 125.00

10.864 Lock Stopper for Butyrometer 4.80

10.866 Lactometer, Sp. Gr. range 1.000 to 1.044 28.00

10.868 Mojjonier Flask as per ISI specifications 180.00

10.870-001 Reichert Wollney's Apparatus, "SGCLABS", for the determination of volatile fatty acids in margarine and butter, with rubber cork fitting. 700.00

10.870-002 Same as Cat. No. 10.911 with standard joint fitting 850.00

10.872-001 Polenske's Apparatus, (R.M. Value Apparatus), "SGCLABS", for the determination of butter fat and analysis of oil, fats, waxes with rubber cork fitting. 700.00

10.872-002b Same as Cat. No. 10.915 with standard joint fitting. 850.00

10.874-300 Flask flat bottom 300 ml for above apparatus. 115.00

10.874-2429 Same as Cat. No. 10.919 with 24/29 socket 160.00

10.876-001 Condenser for Polenske's Apparatus or Reichert Wollney's Apparatus, "SGCLABS", 260.00

10.876-002 Same as Cat No. 10.923 with 24/29 socket. 320.00

10.876-003 Still head for 10.911 or 10.915 75.00

10.878 Still Head with standard joints for 10.913 or 10.917 145.00

10.880 Flask standard marked at 100 & 110 ml. "SGCLABS", 130.00



10.856

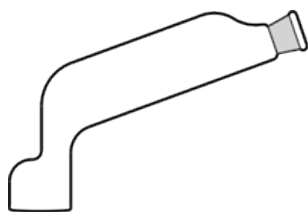

10.868

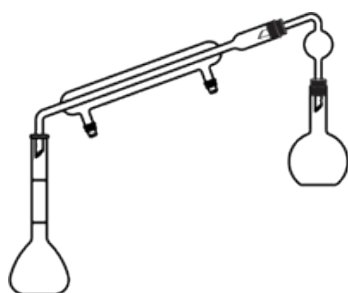

10.870-001

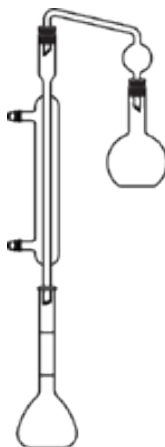

10.872-001

CHROMATOGRAPHY

10.882 Chromatography Columns, "SGCLABS", with integral sintered disc & Stopcock.

Sap Code	Cat No.	Effective Length mm	Disc Dia mm	Price/Piece.
CC-GK-001	882/001	200	10	485.00
CC-GK-002	882/002	300	10	490.00
CC-GK-003	882/003	300	18	650.00
CC-GK-004	882/004	450	30	850.00
CC-GK-005	882/005	500	10	595.00
CC-GK-006	882/006	500	18	750.00
CC-GK-007	882/007	600	30	935.00
CC-GK-008	882/008	600	40	1170.00
CC-GK-009	882/009	1000	40	1430.00



10.882

10.890 Chromatography Columns, "SGCLABS", Plain with stopcock.

Sap Code	Cat No.	Effective Length mm	Disc Dia mm	Price/Piece.
CC-PST-001	890/001	200	10	402.00
CC-PST-002	890/002	300	10	407.00
CC-PST-003	890/003	300	18	460.00
CC-PST-004	890/004	450	30	620.00
CC-PST-005	890/005	500	10	430.00
CC-PST-006	890/006	500	18	650.00
CC-PST-007	890/007	600	30	750.00
CC-PST-008	890/008	600	40	810.00
CC-PST-009	890/009	1000	40	935.00

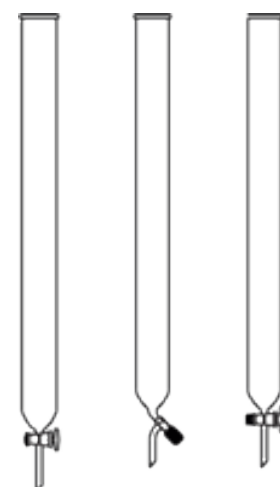

10.890

Note: Any other size and type of Chromatography Columns can also be supplied on Request.

10.894 Gas Tight Micro Litre Syringe with Needle.

Sap Code	Cat No.	Capacity ml.	Price/Piece.
GT-MLS-FN-10	894/10	10	1650.00
GT-MLS-FN-25	894/25	25	1000.00
GT-MLS-FN-50	894/50	50	925.00
GT-MLS-FN-100	894/100	100	925.00
GT-MLS-FN-250	894/250	250	925.00
GT-MLS-FN-500	894/500	500	925.00
GT-MLS-FN-1000	894/1000	1000	1140.00



10.894

10.898 Chromatography Sprayers, "SGCLABS", with rubber bellow.

Sap Code	Cat No.	Capacity ml.	Price/Piece.
CS-RB-100	898/100	100	210.00
CS-RB-150	898/150	150	220.00
CS-RB-250	898/250	250	230.00



10.898

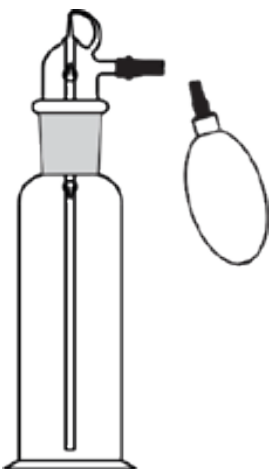

10.900

10.900 Chromatography Sprayers, "SGCLABS", Fisher type with interchangeable joints, rubber bellow.

Sap Code	Cat No.	Capacity ml.	Price/Piece.
CS-FT-25	900/25	25	450.00
CS-FT-50	900/50	50	475.00
CS-FT-100	900/100	100	500.00

SILICA LABORATORY WARE

11.902 Silica Crucibles, "SGCLABS", with lid, translucent, withstands 800°C.

Sap Code	Cat No.	Capacity ml.	Price/Piece.
SC-LT-15	902/15	15	350.00
SC-LT-25	902/25	25	400.00
SC-LT-50	902/50	50	660.00
SC-LT-100	902/100	100	1550.00
SC-LT-80	902/80	80	1310.00
SC-LT-150	902/150	150	2200.00

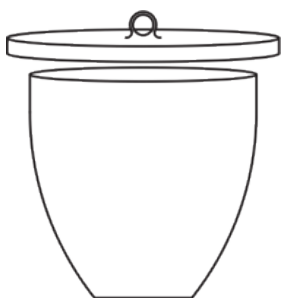

11.902

11.904 Silica Crucibles, "SGCLABS", without lid, translucent, withstands 800°C.

Sap Code	Cat No.	Capacity ml.	Price/Piece.
SC-S-15	904/15	15	178.00
SC-S-25	904/25	25	204.00
SC-S-50	904/50	50	395.00
SC-S-80	904/80	80	710.00
SC-S-100	904/100	100	905.00
SC-S-150	904/150	150	1170.00

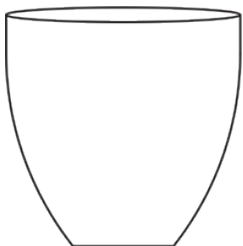

11.904

11.906 Silica Basins, "SGCLABS", with spout, Round Bottom, translucent, withstands 800°C.

Sap Code	Cat No.	Capacity ml.	Dia x Hr. Approx.	Price/Piece.
SB-RBT-20	906/20	20	55 X 23	360.00
SB-RBT-45	906/45	45	75 X 27	520.00
SB-RBT-70	906/70	70	87 X 33	675.00
SB-RBT-85	906/85	85	94 X 36	742.00
SB-RBT-100	906/100	100	100 X 45	1425.00
SB-RBT-200	906/200	200	113 X 47	1750.00



11.906

THERMOMETERS

12.908 Chemical Thermometers, "SGCLABS", Mercury Filled 30 cm. long, accuracy ±1 division, made from Imported Capillary, Screen Printed Graduation.

Sap Code	Cat No.	Range	Division	Price/Piece.
CTH-M-001	908/001	0–50°C	1/1	85.00
CTH-M-002	908/002	0–50°C	1/2	85.00
CTH-M-003	908/003	0–100°C	1/1	85.00
CTH-M-004	908/004	–10–110°C	1/1	85.00
CTH-M-005	908/005	–10–110°C	1/2	85.00
CTH-M-006	908/006	0–150°C	1/1	88.00
CTH-M-007	908/007	0–200°C	1/1	88.00
CTH-M-008	908/008	0–250°C	1/1	88.00
CTH-M-009	908/009	0–300°C	2/1	90.00
CTH-M-010	908/010	0–360°C	2/1	90.00
CTH-M-011	908/011	0–220°F	1/1	85.00
CTH-M-012	908/012	0–80°R	1/1	85.00

Note: Stirring Thermometers of Cat. No. 12.050 can also be supplied on extra cost of Rs. 5.00 per piece.

12.910 Chemical Thermometers, "SGCLABS", Alcohol Filled 30 cm. long, accuracy ±1 division, made from Imported Capillary, Screen Printed Graduation.

Sap Code	Cat No.	Range	Division	Price/Piece.
CTH-AL-001	910/001	–10–50°C	1/1	42.00
CTH-AL-002	910/002	–10–110°C	1/1	42.00
CTH-AL-003	910/003	–10–110°C	½	45.00

12.912 Adjustable PTFE cone 10/19 or 14/23 or 19/26 for holding Thermometers of Cat. No. 12.050, 12.054 & 12.060 280.00

12.914 Precision Chemical Thermometers, "SGCLABS", . Accuracy ±1 division.

Sap Code	Cat No.	Range	Division	Price/Piece.
PC-TH-001	914/001	–10–50°C	1/5	125.00
PC-TH-002	914/002	–10–50°C	1/10	135.00
PC-TH-003	914/003	–10–110°C	1/5	135.00
PC-TH-004	914/004	–10–110°C	1/10	150.00

12.916 Thermometers, "SGCLABS", with cone, enclosed Type. Accuracy ±1 division.

Sap Code	Cat No.	Range	Division	Price/Piece.
TH-C-001	916/001	–10–50°C	10/19	250.00
TH-C-002	916/002	–10–110°C	14/23	320.00
TH-C-003	916/003	0–250°C	14/23	320.00
TH-C-004	916/004	0–360°C	14/23	325.00
TH-C-005	916/005	–10–110°C	19/26	360.00
TH-C-006	916/006	0–250°C	19/26	360.00
TH-C-007	916/007	0–360°C	19/26	365.00



12.908

12.910

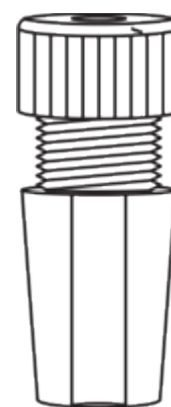

12.912



12.914



12.916



12.920



12.922



12.924-001

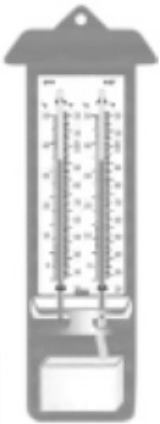

12.924-002



12.926-20



12.926-40



12.932-001

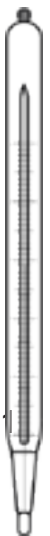

12.934



12.936

12.918 Low Temperature Thermometers, "SGCLABS", (Alcohol Filled) 30cms. long. Accuracy ± 1 division.

Sap Code	Cat No.	Range	Division	Price/Piece.
LT-TH-AL-001	918/001	-30 To +50°C	1°C	98.00
LT-TH-AL-002	918/002	-50 To +50°C	1°C	180.00
LT-TH-AL-0013	918/003	-50 To +100°C	1°C	180.00
LT-TH-AL-004	918/004	-100 To +50°C	1°C	250.00

12.920 Maximum and Minimum Thermometer in plastic case. 140.00

12.922 Maximum and Minimum Thermometer, Superior Quality, Plastic moulded frame similar to Zeal. 350.00

12.924-001 Wet And Dry Thermometer, Superior Quality, Plastic Moulded Frame similar to Zeal. 140.00

12.924-002 — do — Superior Quality, Plastic moulded frame similar to Zeal 350.00

12.926-2 Wall Thermometer in Plastic Groove type Base Plate, 20 cm. 52.00

12.926-40 Wall Thermometer in Plastic Groove type Base Plate, 40 cm. 150.00

12.928 Clinical Thermometer 31.00

12.930 Brewer's Thermometer, (Bath Thermometer), Copper case.

Sap Code	Cat No.	Range	Price/Piece.
BTH-CC-001	930/001	0 To 110°C	330.00
BTH-CC-002	930/002	0 To 150°C	330.00
BTH-CC-003	930/003	0 To 240°F	330.00
BTH-CC-004	930/004	0 To 300°F	330.00

12.930-005 Brewer's Thermometer, (Bath Thermometer), Copper case, combined scale, Range 0 to 150°C and 300°F. 330.00

12.932-001 Soil Thermometer, with brass cone at bottom, fitted in wooden body, range 100°C or 180°F, 100 mm long brass cone. 320.00

12.932-002 Soil Thermometer in aluminium pipe (stick type) range 10-110°C, with pointed edge, Alcohol filled. 250.00

12.934 Dairy Thermometer, with paper scale, range 0 to 100 x 1°C, total length 280 mm. approx. filled with mercury. 170.00

12.936 Psychrometer, (Whirling Hygrometer) in plastic frame, with chart. 440.00

HYDROMETERS

12.938 Specific Gravity Hydrometers, in 100 degree range, shot weighted with paper scale.

Sap Code	Cat No.	Range Sp. Gr.	Price/Piece.
SG-HYD-001	938/001	600-700	98.00
SG-HYD-002	938/002	700-800	78.00
SG-HYD-003	938/003	800-900	78.00
SG-HYD-004	938/004	900-1000	78.00
SG-HYD-005	938/005	1000-1100	78.00
SG-HYD-006	938/006	1100-1200	78.00
SG-HYD-007	938/007	1200-1300	102.00
SG-HYD-008	938/008	1300-1400	102.00
SG-HYD-009	938/009	1400-1500	102.00
SG-HYD-010	938/010	1500-1600	125.00
SG-HYD-011	938/011	1600-1700	125.00
SG-HYD-012	938/012	1700-1800	125.00
SG-HYD-013	938/013	1800-1900	135.00
SG-HYD-014	938/014	1900-2000	135.00

12.940 Universal Hydrometer accurate Range 700-2000 Sp. Gr. 87.00

12.942 Beame Hydrometer, Shot weighted, with paper scale.

Sap Code	Cat No.	Range	Price/Piece.
BE-HYD-LL-001	942/001	Light liquid range 10-70 Be, 0.700-1.000 Sp. Gr.	58.00
BE-HYD-HL-002	942/002	Heavy liquid range 10-70 Be, 1.000-2.000 Sp. Gr.	58.00

12.944 Beame Hydrometer, In 10 degree range, shot weighted with paper scale.

Sap Code	Cat No.	Range	Price/Piece.
BE-HYD-001	944/001	0.10 Be	78.00
BE-HYD-002	944/002	10.20 Be	78.00
BE-HYD-003	944/003	20.30 Be	78.00
BE-HYD-004	944/004	30.40 Be	78.00
BE-HYD-005	944/005	40.50 Be	99.00
BE-HYD-006	944/006	50.60 Be	99.00
BE-HYD-007	944/007	60.70 Be	99.00

12.944 Beame Hydrometer, In 20 degree range, shot weighted with paper scale.

Sap Code	Cat No.	Range	Price/Piece.
-BE-HYD-008	944/008	0.20 Be	78.00
BE-HYD-009	944/009	20.40 Be	78.00
BE-HYD-010	944/010	40.60 Be	99.00



12.938



12.942



12.944



12.946-001



12.946-004

12.946-001 Brix Hydrometer, shot weighted with paper scale, without thermometer.

Sap Code	Cat No.	Range	Price/Piece.
BR-HYD-001	946/001	0-10 Bx, 10-20 Bx, 20-30 Bx	102.00
BR-HYD-001	946/002	30-40 Bx, 40-50 Bx, 50-60 Bx	125.00
BR-HYD-001	946/003	60-70 Bx, 70-80 Bx, 80-90 Bx	102.00
BR-HYD-001	946/003	0-30 Bx, 30-60 Bx, 60-90 Bx	102.00

12.946-004 Brix Hydrometer, shot weighted with paper scale, built in thermometer.

Sap Code	Cat No.	Range	Price/Piece.
BR-HYD-004	946/004	0-10 Bx	320.00
BR-HYD-005	946/005	10-20 Bx	320.00
BR-HYD-006	946/006	20-30 Bx	320.00
BR-HYD-007	946/007	30-40 Bx	320.00
BR-HYD-008	946/008	40-50 Bx	320.00
BR-HYD-009	946/009	50-60 Bx	350.00

12.948 Sike's Hydrometer, shot weighted with paper scale.

Sap Code	Cat No.	Range	Price/Piece.
SK-HYD-001	948/001	0-20	128.00
SK-HYD-002	948/002	20-40	128.00
SK-HYD-003	948/003	40-60	128.00
SK-HYD-004	948/004	60-80	128.00
SK-HYD-005	948/005	80-100	128.00

12.950 Twaddle Hydrometers.

Sap Code	Cat No.	Size No.	Range TW	Price/Piece.
TL-HYD-001	950/001	1	0.26	78.00
TL-HYD-002	950/002	2	24-50	78.00
TL-HYD-003	950/003	3	48-74	78.00
TL-HYD-004	950/004	4	72-104	78.00
TL-HYD-005	950/005	5	102-138	102.00
TL-HYD-006	950/006	6	136-174	102.00

12.952 Battery Hydrometers, complete with specific gravity hydrometer range 1.1 to 1.3, glass jar, rubber stopper and rubber bulb.



12.948



12.950



12.952

PTFE LABORATORY WARE

13.954 PTFE Interchangeable Stopper, Hexagonal head.

Sap Code	Cat No.	Size	Price/Piece.
PTFE-S-HH-001	954/001	10/19	405.00
PTFE-S-HH-002	954/002	14/23	540.00
PTFE-S-HH-003	954/003	19/26	675.00
PTFE-S-HH-004	954/004	24/29	788.00
PTFE-S-HH-005	954/005	29/32	990.00
PTFE-S-HH-006	954/006	34/35	1215.00



13.954

13.956 PTFE Coated Magnetic Needles, Centre Spin.

Sap Code	Cat No.	Length x Dia mm.	Price/Piece.
PTFE-MN-001	956/001	10 X 6	77.00
PTFE-MN-002	956/002	10 X 8	84.00
PTFE-MN-003	956/003	15 X 8	91.00
PTFE-MN-004	956/004	20 X 8	117.00
PTFE-MN-005	956/005	25 X 8	138.00
PTFE-MN-006	956/006	40 X 8	182.00
PTFE-MN-007	956/007	50 X 8	248.00
PTFE-MN-008	956/008	75 X 8	415.00



13.956

13.958 PTFE Beakers with spout.

Sap Code	Cat No.	Capacity ml.	Price/Piece.
PTFE-BE-S-25	958/25	25	619.00
PTFE-BE-S-50	958/50	50	1170.00
PTFE-BE-S-100	958/100	100	2100.00
PTFE-BE-S-250	958/250	250	3940.00
PTFE-BE-S-400	958/400	400	4500.00
PTFE-BE-S-500	958/500	500	5400.00
PTFE-BE-S-1000	958/1000	1000	8550.00
PTFE-BE-S-2000	958/2000	2000	21600.00



13.958

13.960 PTFE Lid for Beakers

Sap Code	Cat No.	Suitable for Beaker Capacity(ml.)	Price/Piece.
PTFE-LID-B-25	960/25	25	68.00
PTFE-LID-B-25	960/50	50	135.00
PTFE-LID-B-25	960/100	100	180.00
PTFE-LID-B-25	960/250	250	270.00
PTFE-LID-B-25	960/400	400	360.00
PTFE-LID-B-25	960/500	500	405.00
PTFE-LID-B-25	960/1000	1000	516.00
PTFE-LID-B-25	960/2000	2000	900.00



13.960



13.962



13.964



13.966



13.968



13.970

13.962 Beakers, Polypropylene, Autoclaveable, Graduated.

Sap Code	Cat No.	Capacity ml.	Price/Piece.
BE-PP-50	962/50	50	9.00
BE-PP-100	962/100	100	11.00
BE-PP-250	962/250	250	22.00
BE-PP-500	962/500	500	32.00
BE-PP-1000	962/1000	1000	54.00
BE-PP-2000	962/2000	2000	113.00

13.964 Reagent Bottles (Narrow Mouth), Screwcap, Polypropylene, Autoclaveable.

Sap Code	Cat No.	Capacity ml.	Price/Piece.
RB-NM-PP-60	964/60	60	16.00
RB-NM-PP-125	964/125	125	22.00
RB-NM-PP-250	964/250	250	36.00
RB-NM-PP-500	964/500	500	45.00
RB-NM-PP-1000	964/1000	1000	76.00

13.966 Reagent Bottles (Wide Mouth), Screwcap, Polypropylene, Autoclaveable.

Sap Code	Cat No.	Capacity ml.	Price/Piece.
RB-WM-PP-60	966/60	60	18.00
RB-WM-PP-125	966/125	125	25.00
RB-WM-PP-250	966/250	250	43.00
RB-WM-PP-500	966/500	500	54.00
RB-WM-PP-1000	966/1000	1000	86.00

13.968 Carboy, Polypropylene, Autoclaveable.

Sap Code	Cat No.	Capacity ltr.	Price/Piece.
CB-PPA-10	968/10	10	1170.00
CB-PPA-20	968/20	20	1620.00

13.970 Aspirator Bottles, Polypropylene, Autoclaveable with Leakproof spigot screwed to the bottle body.

Sap Code	Cat No.	Capacity ltr.	Price/Piece.
AB-PPA-5	970/5	5	864.00
AB-PPA-10	970/10	10	1530.00
AB-PPA-20	970/20	20	2250.00

13.972 Wash Bottles, Polythylene

Sap Code	Cat No.	Capacity ml.	Price/Piece.
WB-PT-125	972/125	125	25.00
WB-PT-250	972/250	250	32.00
WB-PT-500	972/500	500	45.00
WB-PT-1000	972/1000	1000	76.00



13.972

13.974 Flasks Stand Polypropylene, Autoclaveable.
13.976 Connector (T&Y) Polypropylene, Autoclaveable.

Sap Code	Cat No.	Description	Price/Piece.
TC-PP-A-001	976/001	T Connector-6mm	6.00
TC-PP-A-002	976/002	Y Connector-6mm	6.00
TC-PP-A-003	976/003	T Connector-8mm	9.00
TC-PP-A-004	976/004	Y Connector-8mm	9.00
TC-PP-A-005	976/005	T Connector-10mm	14.00
TC-PP-A-006	976/006	Y Connector-10mm	14.00



13.974

13.978 Dessicator (Vaccum) Polypropylene / Polycarbonate, Autoclaveable, with Perforated plate.

Sap Code	Cat No.	Size mm	Price/Piece.
DCV-PPA-150	978/150	150	1890.00
DCV-PPA-200	978/200	200	2880.00
DCV-PPA-250	978/250	250	3600.00
DCV-PPA-300	978/300	300	5760.00



13.976

13.980 Dessicator (Plain) Polypropylene/Polycarbonate, Autoclaveable, with Perforated plate.

Sap Code	Cat No.	Capacity ml.	Price/Piece.
DCP-PPA-150	980/150	150	1152.00
DCP-PPA-200	980/200	200	2088.00
DCP-PPA-250	980/250	250	2880.00
DCP-PPA-300	980/300	300	4860.00



13.978

13.982 Buchner Funnel, Polypropylene, Autoclaveable.

Sap Code	Cat No.	Capacity ml.	Price/Piece.
BF-PPA-70	982/70	70	108.00
BF-PPA-90	982/90	90	135.00
BF-PPA-110	982/110	110	153.00



13.980



13.982

13.984 Analytical Funnel, Polypropylene, Autoclaveable

Sap Code	Cat No.	Dia mm.	Price/Piece.
AF-PPA-35	984/35	35	5.00
AF-PPA-50	984/50	50	6.00
AF-PPA-62	984/62	62	10.00
AF-PPA-75	984/75	75	10.00
AF-PPA-100	984/100	100	22.00

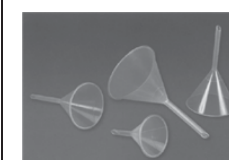

13.984

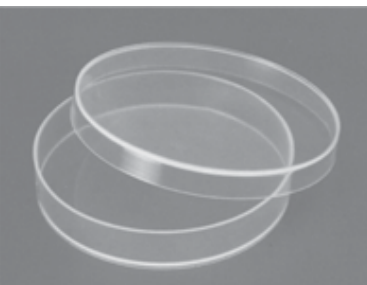

13.986

13.986 Petri Dish (Disposable), Polypropylene, Autoclaveable.

Sap Code	Cat No.	Dia mm.	Price/Piece.
PD-D-PPA-35	986/35	35	7.00
PD-D-PPA-60	986/60	60	9.00
PD-D-PPA-90	986/90	90	11.00

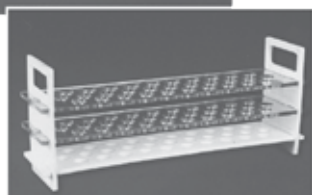
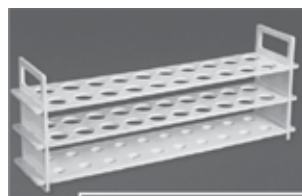

13.988

13.988 Test Tube Stand (3 Tier), Polypropylene, Autoclaveable.

Sap Code	Cat No.	Description	Price/Piece.
TTS-3T-PP-001	988/001	13mm X 31 Tubes	135.00
TTS-3T-PP-002	988/002	16mm X 31 Tubes	135.00
TTS-3T-PP-003	988/003	20mm X 20 Tubes	180.00
TTS-3T-PP-004	988/004	25mm X 12 Tubes	135.00
TTS-3T-PP-005	988/005	25mm X 18 Tubes	180.00
TTS-3T-PP-006	988/006	32mm X 12 Tubes	216.00
TTS-3T-PP-007	988/007	25mm X 36 Tubes	360.00
TTS-3T-PP-008	988/008	13mm X 18 Tubes	81.00
TTS-3T-PP-009	988/009	15mm X 18 Tubes	81.00
TTS-3T-PP-010	988/010	18mm X 12 Tubes	81.00
TTS-3T-PP-011	988/011	13mm X 62 Tubes	270.00
TTS-3T-PP-012	988/012	16mm X 62 Tubes	270.00
TTS-3T-PP-013	988/013	20mm X 40 Tubes	360.00
TTS-3T-PP-014	988/014	13mm X 48 Tubes	180.00
TTS-3T-PP-015	988/015	13mm X 72 Tubes	216.00
TTS-3T-PC-001	990/001	13mm X 31 Tubes	360.00
TTS-3T-PC-002	990/002	16mm X 31 Tubes	360.00
TTS-3T-PC-003	990/003	20mm X 20 Tubes	450.00
TTS-3T-PC-004	990/004	25mm X 12 Tubes	360.00
TTS-3T-PC-005	990/005	13mm X 62 Tubes	720.00
TTS-3T-PC-006	990/006	16mm X 31 Tubes	720.00
TTS-3T-PC-007	990/007	20mm X 40 Tubes	900.00
TTS-3T-PC-008	990/008	25mm X 24 Tubes	720.00
TTS-3T-PC-009	990/009	25mm X 18 Tubes	450.00
TTS-3T-PC-010	990/010	25mm X 36 Tubes	900.00
TTS-3T-PC-011	990/011	32mm X 12 Tubes	522.00



13.992

13.992 Pipette Stand, Polypropylene, Autoclaveable.

Sap Code	Cat No.	Description	Price/Piece.
PS-PP-AH-12	992/12	Horizontal For 12 Pipettes	126.00
PS-PP-AH-28	992/28	Vertical For 28 Pipettes	414.00
PS-PP-AH-94	992/94	Vertical For 94 Pipettes	360.00

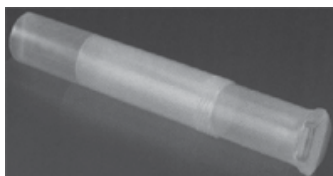

13.994

13.994 Pipette Box, Polypropylene, Autoclaveable.

13.996 Measuring Cylinder, Raised Graduations, Polypropylene, Autoclaveable.

Sap Code	Cat No.	Capacity ml.	Price/Piece.
MC-RG-PPA-10	996/10	10	14.00
MC-RG-PPA-25	996/25	25	23.00
MC-RG-PPA-50	996/50	50	29.00
MC-RG-PPA-100	996/100	100	32.00
MC-RG-PPA-250	996/250	250	72.00
MC-RG-PPA-500	996/500	500	108.00
MC-RG-PPA-1000	996/1000	1000	216.00
MC-RG-PPA-2000	996/2000	2000	630.00



13.996

13.998 Measuring Jugs, Raised Graduation, Polypropylene, Autoclavable.

Sap Code	Cat No.	Capacity ml.	Price/Piece.
MJ-RG-PPA-250	998/250	250	29.00
MJ-RG-PPA-500	998/500	500	36.00
MJ-RG-PPA-1000	998/1000	1000	57.00
MJ-RG-PPA-2000	998/2000	2000	102.00
MJ-RG-PPA-3000	998/3000	3000	162.00
MJ-RG-PPA-5000	998/5000	5000	288.00



13.998

13.1000-001 Stirrer, Polypropylene, Autoclaveable.

Sap Code	Cat No.	Description	Price/Piece.
ST-PPA-001	1000/001	10mm X 250 Mm	18.00
ST-PPA-002	1000/002	6mm X 150 Mm	7.00
ST-PPA-003	1000/003	7mm X 200 Mm	13.00
ST-PPA-004	1000/004	7mm X 250 Mm	14.00
ST-PPA-005	1000/005	7mm X 300 Mm	18.00

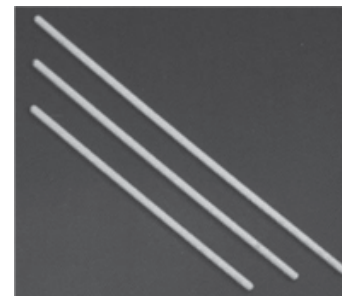

13.1000-001

13.1000-006 Stirrer, Polypropylene, Autoclaveable, 6mm x 245mm 18.00
13.1001 Trays, Polypropylene, Autoclaveable.

Sap Code	Cat No.	Description	Price/Piece.
LT-PPA-001	1001/001	Laboratory Tray 450x350x75mm	288.00
LT-PPA-002	1001/002	Laboratory Tray 375x300x75mm	198.00
LT-PPA-003	1001/003	Utility Tray 375x350x130mm	432.00
LT-PPA-004	1001/004	Carrier Tray 380x240x115mm	495.00
LT-PPA-005	1001/005	Instrument Tray 220x150x70mm	306.00
LT-PPA-006	1001/006	Instrument Tray 450x150x70mm	540.00

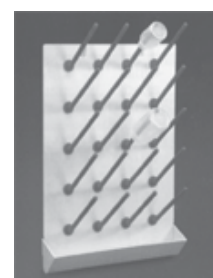

13.1001

13.1002 Draining Rack, Acrylopitrile Butadiene Styrene/Polycarbonate. 2700.00

13.1002

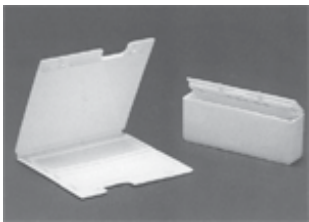

13.1004

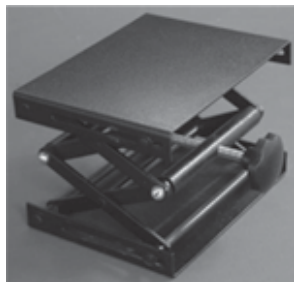

14.1010



14.1012



14.1014-001



14.1016

13.1004 Slide Mailer/ Box, Polypropylene, Autoclaveable.

Sap Code	Cat No.	Description	Price/Piece.
SM-PPA-1	1004/1	1 Slide	9.00
SM-PPA-2	1004/2	2 Slides	15.50
SM-PPA-5	1004/5	5 Slides	16.00
SM-PPA-10	1004/10	10 Slides	22.50
SM-PPA-25	1004/25	25 Slides	54.00
SM-PPA-50	1004/50	50 Slides	108.00
SM-PPA-100	1004/100	100 Slides	180.00

LABORATORY CLAMP & STAND

14.1010 Laboratory Jack, "SGCLABS"

Sap Code	Cat No.	Plate Size	Price/Piece.
LJ-SS-PS-001	1010/001	7 X5 Cm	2200.00
LJ-SS-PS-002	1010/002	12 X 14 Cm	2400.00
LJ-SS-PS-003	1010/003	20 X 20 Cm	4200.00
LJ-SS-PS-004	1010/004	25 X 25 Cm	5400.00
LJ-SS-PS-005	1010/005	30 X 30 Cm	7500.00

14.1012 Burette Clamps, Made of thick Mild Steel sheet. All die-pressed-symmetrical, non-breakable, one holds the burette rests and other presses it due to spring force. Boss head can accommodate upto 18 mm. dia rod.

Sap Code	Cat No.	Description	Price/Piece.
BU-CS-1	1012/01	Single-For One Burette	80.00
BU-CS-2	1012/02	Double-For Two Burettes	150.00

14.1014-001 Universal Clamps, Sheet metal, Die-Pressed, cork lined jaws, can hold up to 12 to 50 mm dia.

Sap Code	Cat No.	Description	Price/Piece.
UC-SM-MS-001	1014/001	M.S. Epoxy Coated	75.00
UC-SM-BC-002	1014/002	Brass Chrome Plated	150.00

14.1014-003 Universal Clamps (Condenser Clamp), Made of casted alloy, Cork lined jaws, can hold 75 mm dia articles, with chrome plated 8 mm. dia 175 mm long mild steel rod for holding in the boss head.

Sap Code	Cat No.	Description	Price/Piece.
UC-A-003	1014/003	Aluminium, Epoxy Coated	160.00
UC-BCP-004	1014/004	Brass, Chrome Plated.	440.00

14.1016 Finger Clamps (Condenser), Made of casted alloy, prongs cross over one another, with chrome plated 8 mm. dia, 175 mm long mild steel rod for holding in the boss head.

Sap Code	Cat No.	Description	Price/Piece.
3FC-A-001	1016/001	3 Finger Clamps—Hold Up To	150.00
3FC-B-002	1016/002	75 mm. dia., Aluminium epoxy coated.— do — Brass, Chrome Plate	300.00
4FC-A-001	1018/001	75 mm. dia., Aluminium epoxy coated	125.00
4FC-B-002	1018/002	— do — Brass, Chrome Plated	300.00



14.1018

14.1020 Condenser Clamps, "JUMBO".

Sap Code	Cat No.	Description	Price/Piece.
CC-BC-001	1020/001	Brass casted, Chrome Plated.4 Fingers covered with Silicon Sleeves, Jawsdo not cross over, can hold upto 125 mm.dia. with 300 x 10 mm, CP rod	1240.00
CC-AC-002	1020/002	-do- Aluminium Castes, Epoxy Coated.	495.00



14.1020

14.1022 Condenser Clamp, 3 Fingers covered with Silicon Sleeves, two keys independently operated, Chrome Plated Mild Steel Rod 300 x 10 mm.



14.1022

Sap Code	Cat No.	Description	Price/Piece.
CC-3F-A-001	1022/001	Aluminium alloy, epoxy coated	440.00
CC-3F-B-002	1022/002	Brass casted, Chrome Plated	760.00



14.1024

14.1024 Condenser Clamp, Co-axial, 3 fingers covered with Silicon sleeves, can hold from 18 mm to 75 mm dia, with 300 x 10 mm. C.P. Rod.

Sap Code	Cat No.	Description	Price/Piece.
CC-3F-BSC-001	1024/001	Brass Sheet, Chrome Plated	355.00
CC-3F-MS-002	1024/002	M.S. Sheet, Epoxy Coated	275.00



14.1026

14.1026 Retort Clamps, Cock lined cylindrical jaws, can hold up to 50mm., with 175x8mm Chrome plate M.S. Rod.

Sap Code	Cat No.	Description	Price/Piece.
RC-AC-001	1026/001	Aluminium casted, Epoxy coated	165.00
RC-BC-002	1026/002	Brass casted, Chrome Plated	305.00



14.1028

14.1028 Boss Head, Cast iron, Black painted, with C.P. Screws.

Sap Code	Cat No.	Description	Price/Piece.
BH-CI-12	1028/12	To Hold Upto 12 Mm. Dia Rod	55.00
BH-CI-16	1028/16	— Do — 16 Mm. Dia. Rod.	88.00
BH-CI-25	1028/25	— Do — 25 Mm. Dia. Rod.	135.00



14.1030

14.1030 Boss Head, Die-pressed, Chrome Plated, or epoxy coated made of thick mild steel strip, can accomodate up to 16mm dia rod.



14.1032



14.1036



14.1038



14.1040



14.1042



14.1044

14.1032 Boss Head, with chrome plated screws, to hold upto 16 mm. dia rod.

Sap Code	Cat No.	Cone	Price/Piece.
BH-CP-A-001	1032/001	Aluminium Casted , Epoxy Coated	60.00
BH-CP-B-002	1032/002	Brass Casted, Chrome Plated	275.00
BH-CP-ZA-003	1032/003	Zinc Alloy Casted	120.00

14.1034 Boss Head, Universal, Multi Purpose, Revolving. 180.00
14.1036 Stand: Rectangular Cast Iron Painted Base with mild steel Chrome Plated or powdered coated rod.

Sap Code	Cat No.	Base Size (Approx)	Rod	Price/Piece.
SR-CI-BR-001	1036/001	6" X 4"	18"X3/8"	315.00
SR-CI-BR-002	1036/002	7" X 5"	24" X 3/8"	340.00
SR-CI-BR-003	1036/003	8" X 5"	24" X 3/8"	350.00
SR-CI-BR-004	1036/004	8" X 5"	24" X 1/2"	400.00
SR-CI-BR-005	1036/005	9" X 6"	30" X 1/2"	650.00
SR-CI-BR-006	1036/006	10" X 6"	24" X 1/2"	820.00
SR-CI-BR-007	1036/007	10" X 8"	30" X 1/2"	940.00
SR-CI-BR-008	1036/008	12" X 7"	36" X 1/2"	1060.00

14.1038 Stand: Tripod shape cast iron hamerton painted base, with mild steel chrome plated rod.

Sap Code	Cat No.	Base Size (Approx)	Rod	Price/Piece.
ST-CI-BR-001	1038/001	7"	24" X 1/2"	395.00
ST-CI-BR-002	1038/002	9"	24" X 1/2"	660.00
ST-CI-BR-003	1038/003	15"	36" X 3/4"	1990.00

14.1040 Stand: A shape cast iron hamertone painted base 6.5" side, with 24" x 1/2" mild steel chrome plated rod. 395.00
14.1042 Tripod Stand: Cast iron black painted top, three balanced chrome plated screwed legs.

Sap Code	Cat No.	Top	Height	Price/Piece.
TS-CIB-T-001	1042/001	Triangular10cm	15cm	78.00
TS-CIB-T-002	1042/002	Triangular10cm	20cm	90.00
TS-CIB-T-003	1042/003	Triangular12cm	20cm	114.00
TS-CIB-T-004	1042/004	Round, Dia 12 Cm	15cm	115.00
TS-CIB-T-005	1042/005	Round, Dia 12cm	20cm	130.00

14.1044 Retort Ring, made of Iron with fixed Boss Head to take upto 12 mm dia Rod.

Sap Code	Cat No.	Dia (Approx.)	Price/Piece.
RR-FBH-2	1044/2	2"	77.00
RR-FBH-3	1044/3	3"	79.00
RR-FBH-4	1044/4	4"	85.00
RR-FBH-5	1044/5	5"	108.00
RR-FBH-6	1044/6	6"	120.00

14.1046 Crucible Tongs

Sap Code	Cat No.	Length	Material	Price/Piece.
CT-MMS-001	1046/001	6"	Mild Steel, C.P.	44.00
CT-MSS-002	1046/002	6"	Stainless Steel	65.00
CT-MMS-003	1046/003	8"	Mild Steel, C.P.	53.00
CT-MSS-004	1046/004	8"	Stainless Steel	87.00
CT-MMS-005	1046/005	12"	Mild Steel, C.P.	155.00
CT-MSS-006	1046/006	12"	Stainless Steel	208.00
CT-MMS-007	1046/007	18"	Stainless Steel	345.00
CT-MSS-008	1046/008	24"	Stainless Steel	560.00

14.1048 Tong for holding Flasks, 12 inches long, Stainless Steel. 220.00
14.1050 Tongs for holding beaker, 12" long, Stainless Steel. 220.00
14.1052-001 Burner Bunsen, made of thick brass pipe 12 mm dia., chrome plated, screw type air regulator. Painted heavy base, 150 mm. height Approx. 155.00

14.1052-002 Burner Bunsen with stopcock 245.00
14.1054-001 Mecker Burner, made of chrome plated brass tube, painted cast iron base, height 180 mm. approx. top dia 25 mm. with mesh. 470.00

14.1054-002 Mecker Burner, with stopcock, made of chrome plated brass tube, painted cast iron base, height 180 mm. approx. top dia 25 mm. with mesh. 545.00

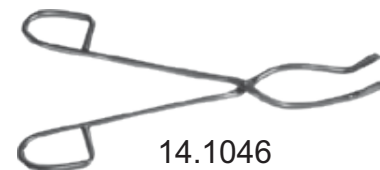
14.1056 Teclu Burner, made of chrome plated brass tube with regulating cone, give a powerful flame and higher temperature, painted cast iron base, height 160 mm. Approx. 520.00

14.1046



14.1048



14.1050



14.1052-001



14.1054



14.1056



14.1058

14.1058 Cork Borers, All brass, chrome plated.

Sap Code	Cat No.	Set of	Price/Piece.
CB-CP-HP-001	1058/001	3, Heavy Pattern	450.00
CB-CP-RQ-002	1058/002	3, Regular Quality	120.00
CB-CP-HP-003	1058/003	6, Heavy Pattern	720.00
CB-CP-RQ-004	1058/004	6, Regular Quality	215.00
CB-CP-HP-005	1058/005	12, Heavy Pattern	2050.00
CB-CP-RQ-006	1058/006	12, Regular Quality	820.00

14.1060 Hoffman's Screw Clip, Brass chrome plated.

Sap Code	Cat No.	Size mm.	Price/Piece.
HSC-BC-12	1060/12	12	84.00
HSC-BC-18	1060/18	18	92.00
HSC-BC-25	1060/25	25	98.00

14.1062 Test Tube Holder, chrome plated. 13.50

14.1060



14.1062

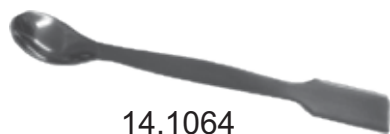

14.1064



14.1066



14.1068

14.1064 Spatula, Stainless Steel, one end flat, one end spoon.

Sap Code	Cat No.	Size mm.	Price/Piece.
S-SS-10	1064/10	10	17.00
S-SS-15	1064/15	15	19.00
S-SS-20	1064/20	20	27.00
S-SS-25	1064/25	25	46.00
S-SS-30	1064/30	30	68.00

14.1066 Swan Neck Tap, Brass, Chrome Plated

Sap Code	Cat No.	Type	Price/Piece.
SNT-BCP-1	1066/1	One Way	1050.00
SNT-BCP-2	1066/2	Two Way	1825.00
SNT-BCP-3	1066/3	Three Way	2025.00

14.1068 Gas Tap, Brass moulded, copper oxidised / Chrome Plated.

Sap Code	Cat No.	Type	Price/Piece.
GT-BM-CP-1	1068/1	One Way	450.00
GT-BM-CP-2	1068/2	Two Way	640.00
GT-BM-CP-3	1068/3	Three Way	870.00
GT-BM-CP-4	1068/4	Four Way	1050.00

LABORATORY RUBBER GOODS

15.1070 Laboratory Rubber Tubing, Extra Soft quality.

Sap Code	Cat No.	Approx. Bore mm.	Wall Thickness mm.	Price/Piece.
LRT-SQ-B4	1070/4	4	1.0	180.00
LRT-SQ-B5	1070/5	5	1.5	225.00
LRT-SQ-B6	1070/6	6	1.5	300.00
LRT-SQ-B7	1070/7	7	1.5	360.00
LRT-SQ-B8	1070/8	8	1.5	390.00
LRT-SQ-B9	1070/9	9	2.0	480.00
LRT-SQ-B10	1070/10	10	2.0	560.00
LRT-SQ-B12	1070/12	12	2.5	650.00
LRT-SQ-B16	1070/16	16	3.0	980.00
LRT-SQ-B19	1070/19	19	3.0	1080.00

15.1072 High Pressure Rubber Tubing, Superior quality.

Sap Code	Cat No.	Approx. Bore mm.	Wall Thickness mm.	Price/Piece.
HP-RT-001	1072/001	3.0	4.5	57.50
HP-RT-002	1072/002	4.5	4.5	60.00
HP-RT-003	1072/003	6.0	4.5	65.00
HP-RT-004	1072/004	8.0	4.5	95.00
HP-RT-005	1072/005	9.0	4.5	106.00
HP-RT-006	1072/006	12.5	6.5	164.00



15.1070



15.1072

15.1074 Ordinary Pressure Rubber Tubing, Superior quality.

Sap Code	Cat No.	Approx. Bore mm.	Wall Thickness mm.	Price/Piece.
OP-RT-001	1074/001	3.0	3	35.00
OP-RT-002	1074/002	4.5	3	42.00
OP-RT-003	1074/003	6.0	3	45.00
OP-RT-004	1074/004	8.0	3	62.00
OP-RT-005	1074/005	9.0	3	70.00
OP-RT-006	1074/006	12.5	4.5	140.00



15.1074

15.1076 Silicon Rubber Tubing

Sap Code	Cat No.	O.D mm.	ID mm.	Wall Thickness mm	Price/Piece.
SRT-001	1076/001	4	2	1	47.00
SRT-002	1076/002	5	3	1	80.00
SRT-003	1076/003	6	4	1	95.00
SRT-004	1076/004	7	5	1	138.00
SRT-005	1076/005	7	4	1.5	138.00
SRT-006	1076/006	8	6	1	180.00
SRT-007	1076/007	8	5	1.5	180.00
SRT-008	1076/008	8	4	2	215.00
SRT-009	1076/009	9	6	1.5	190.00
SRT-010	1076/010	10	7	1.5	250.00
SRT-011	1076/011	10	6	2	250.00
SRT-012	1076/012	11	8	1.5	300.00
SRT-013	1076/013	11	7	2	300.00
SRT-014	1076/014	12	8	2	320.00
SRT-015	1076/015	12	6	3	480.00
SRT-016	1076/016	14	10	2	610.00
SRT-017	1076/017	14	8	3	640.00
SRT-018	1076/018	16	12	2	660.00
SRT-019	1076/019	16	10	3	660.00
SRT-020	1076/020	19	12	3.5	1080.00
SRT-021	1076/021	23	15	4	1450.00
SRT-022	1076/022	25	16	4.5	1200.00



15.1076

15.1078 Silicon Rubber Stoppers

Sap Code	Cat No.	Bottom Dia mm	Top Dia mm	Height mm	Price/Piece.
SR-S-001	1078/001	9	11.5	20	9.50
SR-S-002	1078/002	11	14	24	17.00
SR-S-003	1078/003	13	16	24	18.50
SR-S-004	1078/004	15	18	24	27.00
SR-S-005	1078/005	17	20	26	32.00
SR-S-006	1078/006	18	21	26	36.00
SR-S-007	1078/007	19	22.5	28	44.00
SR-S-008	1078/008	23	25.5	28	62.00
SR-S-009	1078/009	25	28.5	28	75.00
SR-S-010	1078/010	27	31	32	102.00
SR-S-011	1078/011	29	33	32	120.00
SR-S-012	1078/012	31	36	35	160.00
SR-S-013	1078/013	33	38.5	38.5	208.00



15.1078



15.1080



15.1082



15.1084

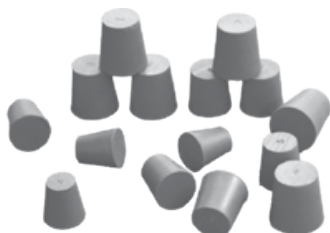

15.1086

15.1080 Suba Seal Stoppers, Rubber, autoclavable with turn over flange and serrations for Test tube.

Sap Code	Cat No.	For Test Tube OD mm.	Price/Piece.
SS-SRA-12	1080/12	12	15.00
SS-SRA-15	1080/15	15	20.00
SS-SRA-18	1080/18	18	22.00
SS-SRA-25	1080/25	25	25.00

15.1082 Suba Seal Stoppers, Rubber, autoclavable with turn over flange, Plain.

Sap Code	Cat No.	For Test Tube OD mm.	Price/Piece.
SS-SR-AP-12	1082/12	12	15.00
SS-SR-AP-15	1082/15	15	20.00
SS-SR-AP-18	1082/18	18	22.00
SS-SR-AP-25	1082/25	25	25.00

15.1084 Rubber Cone for filtration flask.

Sap Code	Cat No.	Suitable for Filter Flask ml.	Price/Piece.
RC-FF-250	1084/250	250	50.00
RC-FF-500	1084/500	500	50.00
RC-FF-1000	1084/1000	1000	75.00
RC-FF-2000	1084/2000	2000	75.00
RC-FF-5000	1084/5000	5000	120.00
RC-FF-10000	1084/10000	10000	250.00

15.1086 Rubber Cork extra soft quality.

Sap Code	Cat No.	Bottom Dia mm.	Top Dia mm.	Height mm	No.	Price/Piece.
RC-ESQ-001	1086/001	13	9	15.5	0	17.00
RC-ESQ-002	1086/002	14	11	18.5	1	24.00
RC-ESQ-003	1086/003	16.5	13	20	2	28.00
RC-ESQ-004	1086/004	19	14	21	3	36.00
RC-ESQ-005	1086/005	21	15	22	4	38.00
RC-ESQ-006	1086/006	22.5	17.5	23	5	44.00
RC-ESQ-007	1086/007	24.5	20	24	6	61.00
RC-ESQ-008	1086/008	26	20	27.5	7	69.00
RC-ESQ-009	1086/009	26.5	21	27.5	8	81.00
RC-ESQ-010	1086/010	28	21.5	31	9	106.00
RC-ESQ-011	1086/011	30	26	32	10	125.00
RC-ESQ-012	1086/012	33.5	30	33.5	11	135.00
RC-ESQ-013	1086/013	34.5	30	34.5	12	150.00
RC-ESQ-014	1086/014	38.5	31	37	13	220.00
RC-ESQ-015	1086/015	41.5	32	42.5	14	250.00
RC-ESQ-016	1086/016	43.5	34	40.5	15	300.00
RC-ESQ-017	1086/017	45	35.5	36.5	16	305.00
RC-ESQ-018	1086/018	49.5	40	40.5	17	360.00

Note: For one hole 0.50 & Two hole 0.80 extra charge.

15.1088	Police Man, Silicon Rubber 5 mm Hole for Insert.	78.00
15.1090	Spatula Silicon	90.00
15.1092.01	Pipette Bulb Small	15.00
15.1092.02	Pipette Bulb Medium	21.00
15.1092.03	Pipette Bulb Large	25.00
15.1092.04	Pipette Bulb Extra Large	27.00
15.1094	Chloroform Bellow with cotton net for Automatic Burette	300.00
15.1096	Automizer Bulb for chromatography sprayer	80.00
15.1098	Rubber Teat for dropper	3.75
15.1100	Propiptor (Pipette Filler) with 3 valves	75.00
15.1102	Hand Grip, Silicon	1000.00
15.1104	Flask Stand, Silicon	1560.00

ANAEROBIC CULTURE JAR

16.1106-001 Anaerobic Culture Jar(Mcintosh and Fildes Pattern), "SGCLABS", for the safe growth of anaerobes through COLD CATALYST. It consists of a glass Jar approx. 23 cm. high x 13 cm. dia., metal cover fitted with two needle valves for evacuating and filling and a sachet for holding the Catalyst, but without catalyst. The jar can be used both with Gas cylinder as well as with Gas packs. Complete with petri dish holder. 7400.00

16.1106-002 - do - with pressure gauge. 7800.00

16.1108 Anaerobic Culture Jar made of Stainless Steel with SS lid and with side tube for Indicator. Complete with cold catalyst. Other details are as per Cat.No. 16.460. With combined Pressure & vacuum gauge. 11800.00

16.1110 Gas packs for anaerobic culture jars. 170.00

16.1112-001 Anaerobic Culture Jar (Anaerobic System without Catalyst) Transparent, unbreakable poly carbonate jar of 3.5 litre capacity having sturdy Aluminum / ABS molded Lid, clamp and sealing ring. Supplied complete with SS Test Tube carrier, SS Petri plate Carrier, 5 Sachets of gas packs, Box of 10 Pcs. of indicator tablets. No need of catalyst and gases.

16.1112-002 Anaerobic Culture Jar (Anaerobic System without Catalyst) Transparent, unbreakable poly carbonate jar of 3.5 litre capacity having sturdy Aluminum Lid, clamp and sealing ring with built in Safety Features, Fitted with Vacuum cum Pressure Gauge, pressure valve and Safety Valve. Supplied with. SS Test Tube carrier, SS Petri Plate Carrier for 10, One Box of 10Pcx. of Anaerobic indicator tablets. 16000.00



15.440



15.1098



15.1100



16.1106-001



16.1108



16.1112-001

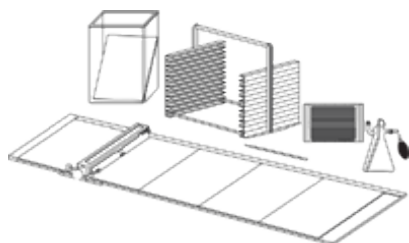

16.1114

CHROMATOGRAPHY

16.1114 Thin Layer Chromatography Kit "SGCLABS", Comprising of moveable applicator (Spreader) with built in arrangement, 0-2 mm, perspex base plate 114 x 23 cm., Aluminum Carrier, perspex spotting temp plate, developing chamber with lid, five T.L.C. plates 20 x 20 cm., two T.L.C. plates 20 x 5 cm., scribe for marking lines, micropipette and glass sprayer with rubber bellow.



16.1132

Sap Code	Cat No.	Description	Price/Piece.
TLC-CPBA-001	1114/001	With Chrome Plated Brass Applicator	8850.00
TLC-AA-002	1114/002	With Aluminium Applicator	6875.00
AB-001	1116/001	Applicator Brass	4600.00
AA-002	1116/002	Applicator Aluminium	3300.00
ST-P-001	1118/001	Spotting Temp Plate, Perspex	475.00
AC-TP-001	1120/001	Aluminium Carrier For Ten Plates Of 20 Cm X 20 Cm	950.00
PR-SS-001	1122/001	Plate Rack Of S.S. For Two Plates, 20x20 Cm.	460.00
TLC-GP-001	1124/001	T.L.C. Glass Plates 20x20 Cm.	50.00
TLC-GP-002	1124/002	— Do — 20x10 Cm.	32.00
TLC-GP-003	1124/003	— Do — 20x 5 Cm	25.00
CH-TC-001	1126/001	Chromatography Tank (Developing Chamber) With Cover For T.L.C. Plates Of Size 20 X 20 Cm.	2250.00
0021126/002	— Do — 20 X 10 Cm.	1900.00	CH-TC-
CH-TC-003	1126/003	— Do — 20 X 5 Cm.	1625.00
PBP-114	1128/114	Perspex Base Plate Size Approx. 114 X 23 Cm.	1415.00
DC-C-001	1130/001	Dessicator Cabinet 30x50x35cm.	6900.00

16.1132 Paper Chromatography Cabinet "SGCLABS", Ascending or Descending, made of teak wood and glass construction. It can accommodate two (troughs) and six glass rods.

Sap Code	Cat No.	Description	Price/Piece.
PCH-C-001	1132/001	Cabinet Size : 60x30x60 Cm. Approx For 4 Filter Papers Of 46x57Cm	12600.00
PCH-C-002	1132/001	Cabinet Size: 80x37.5x65 Cm. Approx. For 6 Filter Papers Of 75x75 Cm. Size	14400.00
GB-C-001	1134/001	Glass Boats For Cabinet 16.510.01	675.00
GB-C-002	1134/002	Glass Boats For Cabinet 16.510.02	800.00

16.1136 Ultra Violet Chromatography Inspection Cabinet, "SGCLABS", for viewing and detecting separated substances on T.L.C. Layers, fitted with long wave (365 nm.) U.V. Lamp for use on 220 volts A.C.

Sap Code	Cat No.	Description	Price/Piece.
UV-CIC-01	1136/01	Fitted With One UV Lamp	6800.00
UV-CIC-02	1136/02	Fitted With Two UV Lamps	7200.00



16.1136

16.1136 Ultra Violet Fluorescence Inspection Cabinet, "SGCLABS", Dual wave, having filter fitted with separate low pressure mercury vapour tubes for short ultra violet (254 nm) and long UV (365 nm) plus separate lamp for visible light. The low pressure mercury vapour tubes facilitate immediate use. 14250.00

ROTARY VACUUM EVAPORATOR

16.1138 "SGCLABS", Rotary Vacuum Flash Evaporator The unit consists of High Torque Hybrid motor with user set able RPM from 10-200, with Digital RPM display, Motorized lifting mechanism upto 150 mm with Touch Buttons, Double Coil Condenser, 800 ml Evaporating Flask & 1000 ml Receiving Flask with S-35 Ball Cup Joint, Vapor Trap, feed tube with Stopcock & PTFE Tube & Vapor pass tube, PTFE / Glass sealing mechanism, Water bath with 1 KW Immersion Heater, fitted with temperature controller cum Indicator, temp. range +5°C ambient to 90°C, Flask ejector for easy removal of evaporating flask. The unit is mounted on Sturdy Epoxy coated metallic stand.

16.1140 "SGCLABS", Rotary Vacuum Flash Evaporator (Digital Model). The unit consists of : Fitted with 40W, AC motor, continuously frequency variable speed control 20-200 RPM, digital display, water bath with RT to 90°C temperature control, Heater 1.5KW, jack lifting upto 150mm, Boiling flask 2000 ml, vertical coil condenser, with automatic feed arrangement, receiver flask with ball cup joint etc. 130000.00

16.1142 "SGCLABS", Rotary Vacuum Flash Evaporator : Comprising of AC non sparking geared drive unit, support stand fitted with Jack arrangement on S.S. rod, continuously variable speed regulator, thermostatically controlled water bath, double coil glass condenser, pear shaped evaporating flask Capacity 800 ml., 1000 ml. receiving flask with ball joints, feeding tube and vapor path tube, with PTFE / Rubber seals for maintaining complete vacuum. 39000.00

Sap Code	Cat No.	Description	Price/Piece.
RV-FE-WBDG-001	1144/001	Same as above, but Water Bath fitted with Digital Temperature Controller cum Indicator.	46500.00
C-DC-35	1146/35	Condenser Double Coil With S-35 Ball Joint.	3750.00
RF-1000	1148/1000	Receiving Flask One Litre Capacity With S-35 Cup Joint.	650.00
BF-S-800	1150/800	Boiling Flask 800 MI. With 24/29 Socket.	525.00
FT-C-001	1152/001	Feed Tube For Condenser.	275.00
VP-T-001	1154/001	Vapour Path Tube.	600.00
SW-C-001	1156/001	Silicon Washer For Condenser	175.00
OS-R-001	1158/001	Oil Seal Rubber	150.00
TS-HC-001	1160/001	Tension Spring For Holding Condenser	60.00
WC-HBF-001	1162/001	Wire Clip To Hold Boiling Flask	45.00



16.1136



16.1138



16.1140



16.1142



16.1164

KJELDHAL APPARATUS

16.1164 Universal Combined Kjeldhal Digestion and Distillation Unit "SGCLABS", Electrically heated, comprising of one single mild steel tubular stand provided with two shelves one above the other. A specially designed glass fume duct with 24/29. Cone openings (suitable for flasks having 24/29 socket) having such provision so that no leakage of fumes takes place. One heater box having individual energy regulators for 500 watts heaters are supplied in digestion part at the lower side. One heater box of above design is supplied in distillation part at the upper side. Distillation part is also provided with brass condenser rack with water circulation systems and clamps. The whole unit is operated on 220 volts AC mains.

Sap Code	Cat No.	Description	Price/Piece.
UN-KD-06-001	1164/001	Complete Unit With Glass Parts For 6 Tests	29500.00
UN-KD-06-001	1164/002	-Do- Without Glass Parts For 6 Tests	22000.00
UN-KD-03-001	1166/001	Complete Unit With Glass Parts For 3 Tests	19250.00
UN-KD-03-002	1166/002	-Do- Without Glass Parts For 3 Tests	13500.00

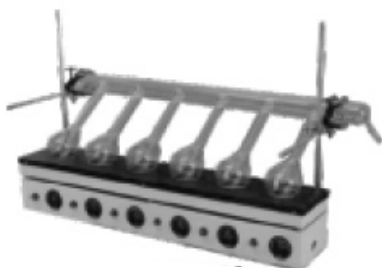

16.1168

16.1168 Kjeldhal Digestion Unit, "SGCLABS", Complete with heating box and fume duct. The 500 watts heaters are 6 inches apart having individual on/off switches and energy regulators. The height of the side clamps provided, is adjustable to accommodate Kjeldhal flasks of 300 ml., 500 ml. or 800 ml. The unit is supplied with Fume Duct. Kindly place order for Kjeldhal flasks extra as per requirement.

Sap Code	Cat No.	Description	Price/Piece.
KD-U-3T-001	1168/001	Unit For 3 Tests With 3x500ml Flasks.	6500.00
KD-U-3T-002	1168/002	Unit For 3 Tests W/O Flasks.	6000.00
KD-U-6T-001	1170/001	Unit For 6 Tests With 6x500ml Flasks.	10500.00
KD-U-6T-002	1170/002	Unit For 6 Tests W/O Flasks.	9200.00
FD-3T-G-001	1172/001	Fume Duct For 3 Tests, Glass.	1000.00
FD-3T-PVC-002	1172/002	Fume Duct For 3 Tests, P.V.C.	600.00
FD-6T-G-003	1172/003	Fume Duct For 6 Tests, Glass.	1800.00
FD-6T-PVC-006	1172/004	Fume Duct For 6 Tests, P.V.C.	1200.00
FK-PN-300	1174/300	Flasks Kjeldhal Plain Neck, 300 ML.	185.00
FK-PN-500	1174/500	Flasks Kjeldhal Plain Neck, 500 ML.	278.00
FK-PN-800	1174/800	Flasks Kjeldhal Plain Neck, 800 ML.	376.00



16.1176

16.1176 Kjeldhal Digestion Unit "SGCLABS", same as Cat. No. 16.550 but with specially designed fume duct to totally avoid leakage of fumes with 24/29 cone adapters for openings suitable to fit Kjeldhal flasks having 24/29 Sockets but w/o flask. Kindly place order for kjeldhal flasks extra as per requirement.

Sap Code	Cat No.	Description	Price/Piece.
KDU-3T-001	1176/001	Unit For 3 Tests With 3x500ml Kjeldhal Flasks	8500.00
KDU-3T-002	1176/002	Unit For 3 Tests W/O Flasks	6600.00
KDU-6T-003	1176/003	Unit For 6 Tests With 6 X 500ml Kjeldhal Flasks.	13850.00
KDU-6T-004	1176/004	Unit For 6 Tests W/O Flasks.	10800.00
SD-FDA-3T-001	1178/001	Specially designed Fume Duct with adapters, for 3 Tests for	2500.00
Cat. No. 16.560.02 & 16.560.04			SD-FDA-
3T-002	1178/002	Specially designed Fume Duct with adapters, for 6 Tests for	4000.00
Cat. No. 16.560.06 & 16.560.08			KF-DU-
300	1180/300	Kjeldhal Flasks suitable for above units 300 ml. Capacity with 24/29 socket.	222.00
KF-DU-500	1180/500	- do - 500 ml. with 24/29 socket.	308.00
KF-DU-800	1180/800	- do - 800 ml. with 24/29 socket.	390.00

16.1182 Kjeldhal Distillation Unit, "SGCLABS", Complete with mild steel tubular stand provided with one heating Box, Brass condenser rack with water circulation system, condenser clamps. Heater box is provided with top to receive Kjeldhal flasks, with electric heating elements of 500 watts each connected through individual on/off switches and energy regulators, supplied with or without glass parts.

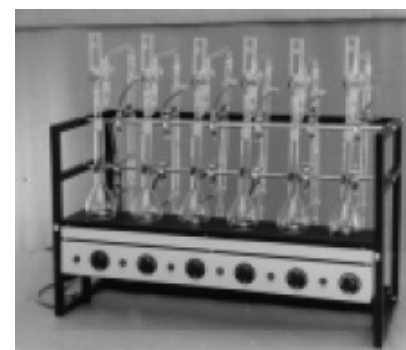

16.1182

Sap Code	Cat No.	Description	Price/Piece.
KDU-3T-001	1182/001	Unit For 3 Tests W/O Glass Parts	9500.00
KDU-3T-002	1182/002	Unit For 3 Tests With Glass Parts	13250.00
KDU-6T-003	1182/003	Unit For 6 Tests W/O Glass Parts	14250.00
KDU-6T-004	1182/004	Unit For 6 Tests With Glass Parts	22000.00
KDU-GPC-500	1184/500	Kjeldhal Distillation Unit Glass Parts Consisting of Kjeldhal flask 500 ml,	1250.00

multiple adapter dropping funnel

SOXHLET HEATING UNIT

16.1186 Soxhlet Extraction Heating Unit, "SGCLABS", Suitable for flasks of 100ml, 150ml, 250ml or 500ml Capacity. Unit is supplied with Heating Box fitted with Heaters (Hot Plates or Heating Mantles) individual energy regulators, neon lights, etc. adjustable rod, clamps & boss heads, but without glass parts.

Sap Code	Cat No.	Description	Price/Piece.
SE-HU-3HP-001	1186/001	Unit With 3 Hot Plate Type Heaters	7500.00
SE-HU-6HP-002	1186/002	Unit With 6 Hot Plate Type Heaters	13250.00
SE-HU-3MT-001	1188/001	Unit With 3 Mantle Type Heaters	6500.00
SE-HU-6MT-002	1188/002	Unit With 6 Mantle Type Heaters	11250.00
SE-HU-CF-6T-001	1190/001	Unit Crude Fiber Estimation, Hot Plate type for 6 Tests, complete with 6 x 1000 ml. Tall form beakers, 6 Bulb shape condensers,	18000.00

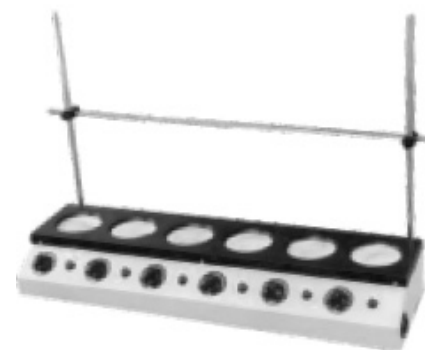

16.1186



16.1192



16.1194

16.1192 C.O.D. Digestion Apparatus, "SGCLABS", Aluminium Dry heating Block with 15 nos. cavities to accommodate 40mm. dia tubes, heaters are placed below the block, ensures uniform heating, in a sheet metal housing, epoxy coated, temperature upto 200°C is controlled by digital temperature controller cum indicator, unit is fitted with timer, supplied with fifteen sets of glass reaction vessels and air condensers with standard joint
38500.00

16.1194 Heating Mantles, "SGCLABS", made of Knitted Glass Yarn, heaters are fitted beneath it, which provides uniform heating of flasks upto 400°C. The mantles are fitted in a nicely painted sheet metal case, filled with Glass Wool insulations, provided with an energy regulator, indicator and a cord.

Sap Code	Cat No.	Capacity ml.	Watts	Price/Piece.
HT-M-50	1194/50	50	60	1050.00
HT-M-100	1194/100	100	60	1050.00
HT-M-250	1194/250	250	150	1160.00
HT-M-500	1194/500	500	200	1240.00
HT-M-1000	1194/1000	1000	300	1560.00
HT-M-2000	1194/2000	2000	450	1800.00
HT-M-3000	1194/3000	3000	450	2000.00
HT-M-5000	1194/5000	5000	600	2400.00
HT-M-10000	1194/10000	10000	2x600	4100.00
HT-M-20000	1194/20000	20000	3x600	5800.00
HT-M-50000	1194/50000	50000	6x600	14000.00

Spare Mantles with Heaters For Replacement

SM-HT-50	1196/50	50	60	280.00
SM-HT-100	1196/100	100	60	280.00
SM-HT-250	1196/250	250	150	290.00
SM-HT-500	1196/500	500	200	340.00
SM-HT-1000	1196/1000	1000	300	425.00
SM-HT-2000	1196/2000	2000	450	530.00
SM-HT-3000	1196/3000	3000	450	600.00
SM-HT-5000	1196/5000	5000	600	810.00
SM-HT-10000	1196/10000	10000	2x600	1260.00
SM-HT-20000	1196/20000	20000	3x600	2100.00
SM-HT-50000	1196/50000	50000	6x600	4800.00

Heating Tape made of Knitted Glass Yarn sleeve, heater is fit sleeve, can be used for heating upto 400°C. eed in the

Sap Code	Cat No.	Length	Width	Watts	Price/Piece.
HT-KGYS-001	1198/001	135/125mm	20mm	125	1050.00
HT-KGYS-002	1198/002	260/250mm	20mm	250	1400.00
HT-KGYS-003	1198/003	510/500mm	20mm	500	2000.00
HT-KGYS-004	1198/004	510/500mm	40mm	1000	2650.00
TCU-ER-001	1200/001	Temp. Control Unit with energy regulator, wire cord and multi			1425.00

16.1202 Hot Plates, "SGCLABS", Mounted on a thick M.S. sheet body, a smooth surface cast iron plate fitted with an electrically operated element laid under the plate. A three step rotary switch works on 220/230 volts A.C. controls heating. The plate is finished in heat resistant black and the body in stoved blue white painted.

Sap Code	Cat No.	Type	Price/Piece.
HP-R-001	1202/001	Round 20 Cm Dia Approx,W/O Energy Regulator	22500
HP-R-002	1202/002	-Do- With Energy Regulator	2450.00
HP-R-003	1202/003	Round 20 Cm Dia, Double, W/O Energy Regulator	4100.00
HP-R-004	1202/004	-Do- With Energy Regulator	4400.00
HP-R-005	1202/005	Rectangular 30x25 Cm, W/O Energy Regulator	3900.00
HP-R-006	1202/006	-Do- With Energy Regulator	4300.00
HP-R-007	1202/007	Rectangular 40x25 Cm, W/O Energy Regulator	5225.00
HP-R-008	1202/008	-Do- With Energy Regulator	5610.00
HP-R-009	1202/009	Rectangular 45x30 Cm, W/O Energy Regulator	5750.00
HP-R-010	1202/010	-Do- With Energy Regulator	6110.00
HP-R-011	1202/011	Rectangular 45x60 Cm, W/O Energy Regulator	9150.00
HP-R-012	1202/012	-Do- With Energy Regulator	9450.00
STH-R-001	1204/001	Spiral Type Heater, Round, W/O Energy Regulator	2890.00
STH-RER-002	1204/002	Do- With Energy Regulator	3180.00



16.1202



16.1206 Laboratory Stirrers, "SGCLABS", Equipped with noiseless universal motor fitted with ball bearings, stainless steel stirring shaft fitted with three bladed propeller and retort stand having cast iron base, S.S. vertical and horizontal rods and a mount, continuous speed control for varying speed upto 4000 RPM.

16.608.02 -do- but motor shaft fitted with chuck 8600.00
10000.00

16.1208 Magnetic Stirrer, "SGCLABS", A Fractional Horse Power motor mounted in a sheet metal housing, fitted with speed regulator, max. Speed 1200 RPM. Top plate stainless steel, cap 1 to 2 litre, supplied with PTFE coated stirring bar.

Sap Code	Cat No.	Description	Price/Piece.
MG-ST-001	1210/001	Without Hot Plate	3400.00
MG-ST-002	1210/002	With Hot Plate And Energy Regulator	3950.00
MG-ST-003	1210/003	Cap. 5 Litre, Without Hot Plate	4175.00
MG-ST-004	1210/004	Cap. 5 Litre, With Hot Plate And Energy Regulator	4600.00
MG-ST-005	1210/005	Rotamantle With Magnetic Stirrer 2 Ltr. Cap.	5850.00
MG-ST-006	1210/006	Magnetic Stirrer Motorless Single Point	7000.00
MG-ST-007	1210/007	Magnetic Stirrer Motorless With Hotplate	14200.00



16.1206

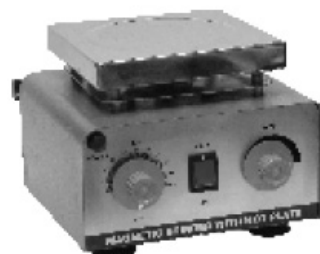

16.1208



16.1212



16.1214



16.1216



16.1218

16.1212 Water Baths Serological, "SGCLABS", Double Walled, outer Mild Steel Sheet, Epoxy Coated, Inner Chamber of Stainless Steel fitted with immersion heater, indicators, temperature upto 65°C, ± 1.0°C, is controlled by Digital Temperature Indicator cum Controller, supplied with lid and cord, but without racks.

Sap Code	Cat No.	Inner Chamber mm	Price/Piece.
WB-SR-001	1212/001	300 X 175 X 175	6250.00
WB-SR-002	1212/002	300 X 250 X 175	7000.00
WB-SR-003	1212/003	375 X 300 X 175	9100.00
WB-SR-004	1212/004	450 X 300 X 175	11100.00
WB-SR-005	1212/005	600 X 300 X 175	13500.00

16.1214 Water Baths, "SGCLABS", Double Walled, Outer Mild Steel Sheet, Epoxy coated, Inner Chamber of Stainless Steel, Temp. is controlled by Digital Temperature Indicator cum Controller from ambient to 95°C ± 1°C, fitted with on/off switch, supplied with concentric rings and a cord.

Sap Code	Cat No.	Inner Chamber mml.	No. of Holes	Price/Piece.
WB-001	1214/001	300 X 250 X 100	6	11250.00
WB-002	1214/002	400 X 300 X 100	12	15000.00

16.1216 Precision Water Baths, "SGCLABS", Double Walled, outer Mild Steel Sheet, Epoxy Coated, Inner Chamber of Stainless Steel, fitted with immersion heater, Stirrer with speed regulator, Glass Window, Indicators and PID temperature controller. Temperature range 5°C above ambient to 100°C ± 0.1 °c. Supplied with cord.

Sap Code	Cat No.	Inner Chamber mm	Price/Piece.
PWB-001	1216/001	425 X 250 X 225	28000.00
PWB-002	1216/002	450 X 375 X 375	32000.00
PWB-003	1216/003	600 X 450 X 450	46000.00

16.1218 Water Bath Incubator Shaker, "SGCLABS", Double Walled, Outer Mild Steel Sheet, Epoxy coated, Inner Chamber Stainless Steel, S.S. pyramidal lid. The bath has an oscillating tray on rollers, oscillated through geared variable speed motor, Oscillation, Speed range is between 40 to 140 cycles per minute. The shaking tray can either hold test tubes or conical flasks of 25 to 1000 ml. cap. (Cap. to be specified by the user, while ordering). Temperature is controlled by the PID temperature controller, range ± 5° above ambient to 100°C ± 0.5°C. Provided with a cord and plug to work on 220 / 230 V AC supply.v

Sap Code	Cat No.	Shaking Tray (WxDxH)	Price/Piece.
WB-IS-ST-001	1218/001	275 X 275 X 150 Mm	32000.00
WB-IS-ST-002	1218/001	405 X 300 X 150 Mm	88000.00

16.1220 Water Bath Universal, "SGCLABS", Temp. is controlled by Digital Temperature Indicator cum Controller, double walled, stainless steel chamber, one pyramidal lid and the other rectangular with holes covered with concentric rings, provided with water over flow arrangement, immersion heater, pilot lamp and on/off switch.

Sap Code	Cat No.	Inner Chamber mm	Price/Piece.
WB-UN-001	1220/001	300 X 225 X 175	8640.00
WB-UN-002	1220/001	450 X 300 X 175	11880.00



16.1220

16.1222 Water Bath Rectangular, "SGCLABS", Single Walled Stainless Steel Chamber, Stainless steel top with holes and concentric rings, water over flow arrangement, rests on an angle iron frame. It is fitted with an immersion heater which is self ejecting on getting dry.

Sap Code	Cat No.	Inner Chamber mm	Price/Piece.
WB-R-001	1222/001	6 Holes Of 7.5 Cm Dia (300 X 250 X 100 Mm)	3600.00
WB-R-002	1222/001	12 Holes Of 7.5 Cm Dia (350 X 400 X 100 Mm)	5600.00



16.1224

16.1224 Cylindrical Oil Bath, "SGCLABS", Double walled, inner chamber of stainless steel, temp. range 50° to 300°C, temperature is controlled by Digital Temperature Indicator cum Controller.

Sap Code	Cat. No.	Capacity ml.	Watts	Price/Piece.
CL-OB-1	1224/1	1 Litre	500	12000.00
CL-OB-2	1224/2	2 Litre	1000	12400.00
CL-OB-3	1224/3/5	3/5 Litre	1500	13700.00
CL-OB-4	1224/10	10 Litre	2000	17000.00

16.1226 Melting Point Apparatus, "SGCLABS", A metallic heating block heated with superior quality element. A focusable lens, a shadowless lamp., regulator to control the heat. Unit is housed in a cast metal,. pannel fitted with neon light, on/ off switch and regulator,.knob and a thermometer holding rod.



16.1226

16.1228 Digital Melting Point Apparatus, "SGCLABS", Designed for accurate determination of melting points of solid samples. Apparatus comprises of Cylindrical Silicon oil bath, built in magnetic stirrer with speed controller, electronic heat controller, Digital Temp. display with PT 100 sensor, Glare free background light with adjustable light intensity, provision for holding the melting point display. Temp.range 2° above RT-250°C ± 1.0°C

Sap Code	Cat No.	Description	Price/Piece.
DM-PA-3	1228/3	3½ Digit LED	19250.00
DM-PA-4	1228/4	4½ Digit LED	26250.00



16.1228



16.1229

16.1229 Water Stills, Manesty Type, "SGCLABS", Complete stainless steel body, electrically operated, easily replaceable immersion type heaters and wall mounting arrangement.

Sap Code	Cat No.	Output	Price/Piece.
WS-MT-2	1229/2	Approx. 2 Litre/Hr.	5000.00
WS-MT-4	1229/2	Approx. 3/4 Litre/Hr.	5800.00



16.1230

16.1230 Oven Universal "SGCLABS", Double walled, outer body M.S. Sheet epoxy coated, Glass Wood insulation, inn between elements on three sides, fitted with Digital Temperature Indicator cum Controller to control, temp. +5° Ambient to 250°C ± 1°C, Synthetic Rubber/ Fibre gasket at door, adjustable shelves, two indicators, and on/off switch to work on 220/230 volts A.C., supplied with cord.

Sap Code	Cat No.	Inner Chamber mm.	Price/Piece.
OV-DW-001	1230/001	S.S : 300 X 300 X 300	13500.00
OV-DW-002	1230/002	S.S : 350 X 350 X 350	13850.00
OV-DW-003	1230/003	S.S : 450 X 450 X 450	17400.00
OV-DW-004	1230/004	S.S : 600 X 450 X 450	22800.00
OV-DW-005	1230/005	S.S : 600 X 600 X 600	26000.00

(Air circulating fan can be fitted in each size if required at an extra cost of Rs. 2500.00 and for ovens of 300°C, 25% will be charged extra. The above ovens can also be supplied with P. I. D. instead of Digital Temperature Indicator cum Controller at an extra cost of Rs. 7200.00 each.)



16.1232

16.1232 Incubator Universal, "SGCLABS", Double walled, outer body M.S. Sheet, epoxy coated, Glass wool Insulation in between the chamber and outer body, fitted with Digital Temperature Indicator cum Controller to control temp.+5° Ambient to 80°C ± 1°C. Door has double viewing window, with adjustable shelves, two indicators, on/off switch, work on 220/230 volts, supplied with cord.

Sap Code	Cat No.	Inner Chamber mm.	Price/Piece.
IU-SS-001	1232/001	S.S: 300 X 300 X 300	13650.00
IU-SS-002	1232/002	S.S: 350 X 350 X 350	14950.00
IU-SS-003	1232/003	S.S: 450 X 450 X 450	17500.00
IU-SS-004	1232/004	S.S: 600 X 450 X 450	23200.00
IU-SS-005	1232/005	S.S: 600 X 600 X 600	26500.00

(Air circulating fan can be fitted in each size if required at an extra cost. The above Incubators can also be supplied with P. I. D. instead of Digital Temperature Indicator cum Controller at an extra cost)

16.1234 Laboratory Autoclave Vertical, "SGCLABS", Electrically operated, double walled. Boiler made of stainless steel. outer Mild Steel, S.S. Lid, having radial locking system. Working pressure 5 p.s.i. to 15 p.s.i. safety valve; Complete with water level indicator, control box fitted with automatic pressure control switch, pressure gauge, steam release valve; pilot lamp, on / off switch for operation on 220 volts A/C main. Complete with Stainless Steel Basket.

Sap Code	Cat No.	Boiler (Depth x Dia mm)	Price/Piece.
LA-VB-001	1234/001	450 X 250	42000.00
LA-VB-002	1234/002	500 X 300	47000.00
LA-VB-003	1234/003	550 X 350	54000.00
LA-VB-004	1234/004	600 X 450	71000.00
LA-VB-005	1234/005	750 X 550	98000.00

16.1236 Vortex Shaker, "SGCLABS", Vibration type, variable speed, neoprene cup impart vigorous agitation to tubes, with touch. 3800.00

16.1238 V.D.R.L. Shaker, "SGCLABS", Platform 300 x 300 mm., variable speed, supplied with cord and plug to work on 220V, 50/60Hz. 6000.00

16.1240 Ultrasonic Cleaner (Sonicator) : Microprocessor based digital timer, automatic frequency tuning, ultrasonic frequency 33 ± 3KHz, autodegassing, SS tank and housing, fitted with drain valve, supplied with basket.

Sap Code	Cat. No.	Size	Cap.lts. (Approx.)	Price/Piece.
UL-CS-001	1240/001	7"X4"X3"	1.5	15900.00
UL-CS-002	1240/002	9"X6"X4"	3.5	30150.00
UL-CS-003	1240/003	12"X6"X6"	6.5	48500.00

1. Water Heater only, for above 3 Models 3550.00
2. Digital Temp. controller cum Indicator for 3.5 & 6.5 ltr models

16.1242 Rectangular Muffle Furnance, "SGCLABS", (Laboratory model) Light Weight, Outer casing made of thick PCRC sheet, duly powder coated, heating elements made of kanthal. A-1 wire are wound on the ceramic muffle, ceramic fibre insulation is provided on all sides. Temperature control unit consists of Digital Temperature Indicator cum Controller, fitted on the front with two pilot lamps, one pyrometer, thermocouple, silver thermal fuse, main lead with power plug to work on 220 / 230 volts or 400 / 440 volts A.C. Max. Temperature is 1000°C, working temperature 900°C.

Sap Code	Cat No.	Muffle Size (WxDxH)	Price/Piece.
RC-MF-001	1242/001	100 X 100 X 225mm	13200.00
RC-MF-002	1242/002	125 X 125 X 300mm	16000.00
RC-MF-003	1242/003	150 X 150 X 300mm	16800.00
RC-MF-004	1242/004	200 X 200 X 300mm	27000.00



16.1234



16.1236



16.1238



16.1240



16.1242



16.1244

16.1244 Vacuum Oven, "SGCLABS", Double walled with Outer M.S. sheet duly epoxy coated and inner made up of heavy gauge S.S. sheet. Gap between the two is filled with high grade glasswool to avoid thermal loss. Temp. range 50° to 150°C ± 1°C, fitted with digital controller cum indicator. Unit is capable of withstanding high vacuum. Provided with vacuum gauge, see through transparent window of toughened glass and one shelf. Works on 220 / 230 volts A.C. Supplied without Vacuum Pump.

Sap Code	Cat No.	Dia x Depth	Price/Piece.
VO-DW-001	1244/001	250x250mm	37300.00
VO-DW-002	1244/002	300x300mm	45000.00

(The above ovens can also be supplied with P.I.D. instead of Digital Temperature Indicator cum Controller at an extra cost of Rs. 7200.00 each.)

MICRO PIPETTES

17.1246 Variable Volume Micro Pipette, with Digital Display, stream lined tip ejector, two step operation click stop, easy adjustment of volume by turning the plunger, autoclave tip.

Sap Code	Cat No.	Volume (Range)	Inc lμ	Price/Piece.
VV-MP-001	1246/001	0.2-2.0 μl	0.01	1980.00
VV-MP-002	1246/002	0.5-1.0 μl	0.1	1980.00
VV-MP-003	1246/003	2-20 μl	0.1	1980.00
VV-MP-004	1246/004	5-50 μl	1.0	1980.00
VV-MP-005	1246/005	10-100 μl	1.0	2200.00
VV-MP-006	1246/006	20-200 μl	1.0	2200.00
VV-MP-007	1246/007	100-1000 μl	10.0	2200.00
VV-MP-008	1246/008	0.5-5 ml	100.0	2200.00
VV-MP-009	1246/009	1-10ml	100.0	2200.00



17.700/17.710

17.1248 Fixed Volume Micro pipette, with Digital Display. stream lined tip ejector. two step operation

Sap Code	Cat No.	Volume μl	Price/Piece.
FV-MP-001	1248/001	1.0	1290.00
FV-MP-002	1248/002	2.0	1290.00
FV-MP-003	1248/003	5.0	1290.00
FV-MP-004	1248/004	10.0	1290.00
FV-MP-005	1248/005	20.0	1290.00
FV-MP-006	1248/006	25.0	1290.00
FV-MP-007	1248/007	50.0	1290.00
FV-MP-008	1248/008	100.0	1290.00
FV-MP-009	1248/009	200.0	1290.00
FV-MP-010	1248/010	250.0	1290.00
FV-MP-011	1248/011	500.0	1290.00
FV-MP-012	1248/012	1000.0	1290.00
FV-MP-013	1248/013	2000.0	1290.00
FV-MP-014	1248/014	5000.0	1290.00
FV-MP-015	1248/015	10000.0	1290.00

Note : Any Capacity Micro pipettes can also be supplied on demand.

17.1250 Multichannel (Eight) Micro pipettes, with Digital Display, Stream Lined tip ejector two step operation, easy adjustment of volume by turning the plunger.

Sap Code	Cat No.	Capacity Range	Price/Piece.
MC-MP-001	1250/001	5 to 50 ml	16900.00
MC-MP-002	1250/002	40 to 200 ml	16900.00

17.1252 Tips for Micro pipette.

Sap Code	Cat No.	Capacity (Range)	Pk. Size	Price/Piece.
T-MP-200	1252/200	upto 200ml	1000	500.00
T-MP-1000	1252/1000	upto 1000ml	1000	700.00
T-MP-5000	1252/5000	upto 5000ml	100	300.00

17.1254 Stand for Micro pipettes. 900.00

17.1256 Bottle top Dispensers: All parts which comes in contact with reagents are made of PTFE, FEP and Borosilicate Glass. so can be used for all Laboratory Reagents dispensing needs. High accuracy and precision is ensured through several stages of strict quality checks during manufacturing. Each Dispenser is calibrated in accordance with ISO 8665 Standard, and supplied with certificate.

Product Information :

Piston	PTFE
Cylinder	Glass
Value Assembly	Glass
Volume adjustment	Screw Type
Delivery Tube	FEP
Inlet Tube	FEP
Compatibility	Excellent with all reagents except HF.

Each dispenser is supplied with 1 standard adapter of 30mm thread and 5 adapters of 28, 32, 36, 40 & 45mm. to fit in most of the reagent bottles in Laboratories.

Note : Instruments is fully autoclave able.

Sap Code	Cat No.	Volume Range MI.	Increment μ l	Price/Piece.
B-TD-001	1256/001	0.25-2.5	0.05	8500.00
B-TD-002	1256/002	0.5-5	0.1	8500.00
B-TD-003	1256/003	1-10	0.2	8500.00
B-TD-004	1256/004	2.5-30	0.5	12200.00
B-TD-005	1256/005	5-60	0.5	12200.00



17.1250



17.1252



17.1254



17.1256

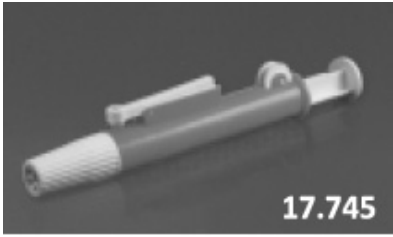

17.745

17.1258 Pipette Pump Acrylonitrile Butadiene Styrene (ABS.)

Sap Code	Cat No.	Capacity (ml.)	Price/Piece.
PP-ABS-2	1258/2	2	360.00
PP-ABS-10	1258/10	10	360.00
PP-ABS-25	1258/25	25	414.00



17.1260

17.1260 Electronic Pipette Filling Device : An efficient and reliable to suit all types of Pipetting needs. 6960.00

Features :

- Continous adjustment of pump speed during operation.
- Silicon collet suitable to hold firmly upto 100ml. pipettes.
- Membrane filter provided prevents Aerosol Contamination and liquid to enter the device.
- Rechargeable Ni-MH batteries used in combination with the low power circuit and Vacuum/Pressure Pump, allows 8 ht. continuous operation.
- Battery charge is provided with each piece.
- Two LEDs to show Low charging and charging status.

INDEX

A

Adapters	36-41
Air Condenser	32-34
Air Leak Tube	41
Allihn Condensers	34
Ammonia Distillation	45
Anaerobic Culture Jars	82
Aspirator	22,71
Assemblies	45,47
Autoclave	92
Automizer Buld	82

B

B.O.D. Bottles	23
Ball & Socket	35
Ball & Socket Clip	35
Beakers	18-19,70-71
Blood Sugar Tubes	18
Boiling Flask	28
Boss Heads	76,77
Bottle Top Dispensers	94
Bottles	20-23,60-61,71-72
Buchner Flasks	31
Buchner Funnel	52-53,72
Bulb Condenser	33-34
Burettes	1-4
Burners	78
Butyrometer	63

C

COD Digestion Apparatus	87
Cal. Chloride Tower / Tubes	58-59.
Centrifuge Tube	15
Chloroform Bellow	82
Chromatography Tank	24,82
Chromatography Column	64
Chromatography Sprayers	64-65
Clamps	75-77
Clevenger Apparatus	47
Clinical Lab. Glassware	56-58
Co-Agulation tube	18
Coil Condensers	32-34
Condensers	32-34
Conductivity Cell	62
Cones	35
Conical Flasks	26-27,31
Cork Borers	78
Counting Chamber	57
Cover Glasses	57
Crucibles	52-54
Crude Fibre Estimation	85-86
Crystallizing Dishes	23
Culture Tubes	14
Cylinder, Measuring	10-13,74

D

Dairy & Milk Testing Apparatus	63
Davies Condensers	33
Dean & Stark Apparatus	46-47
Dessicators	24,72
Dishes	23,73
Dissolution Bowl	62
Distillation Apparatus	45-51
Distillation Flask	28
Draining Rack	74
Dropper	61
Dropping Bottles	22,60-61
Dropping Funnels	43-44
Drying Tube	40
Durham Tube	18

E

Erlenmeyer Flasks	26-27,31
ESR Pipette	8
Essential Oil Determination	
Ether Condensers	34
Extractors	46

F

Filter Apparatus	52-54
Filter Flask	26-27,31
Filter Holders, SS	54
Filter Pump	62
Filter Tubes	62
Filtering Funnel	25
Flask Stand	72,82
Flasks	51,66-3
Flat Bottom Flask	28-29
Florentine Flask	32
Friedrich Condensers	34
Funnels	25,42-45,72
Furnace, Muffle	92

G

Gas Analysis	58-60
Gas Collecting Tubes	59
Gas Generator Kipps	60
Gas Jar	60
Gas Tap	79
Gas Tight Micro Litre Syringe	64
Gas Washing Bottles	60
Gooch Crucible	52

H

Haematocrit Capillaries	56
Haemocytometer	57
Haemometer	57
Haffkine Flask	28
hand Grip	82
Heat Exchanger	49
Heating Mantle	87
Hoffman's Screw Clip	78
Hoffman's Voltmeter	62
Hot Plate	88
Hydrometer	68-69

I

Impinger	58
Incubator	91
Inland Revenue Condensers	33
Iodine Flask	27

J

Jack, Laboratory	75
Jars	24-25
Joints, Standard	35-36

K

Kipp's Apparatus	60
Kjeldahl Digestion Tubes	18
Kjeldahl Dist. Assembly	46
Kjeldahl Flask	27,31
Kjeldahl App., Electrical	85-87
Kohlraush Flask	10

L

Laboratory Jack	75
Laboratory Metal Ware	75-79
laboratory Stirrer	88
Lactometer	63
Liebig Condensers	32,34

M

Mac-Cartney Bottles	23
Magnetic Needle	70
Magnetic Stirrer	88
Markham Distillation Unit	47
Measuring Cylinders	10-13
Melting Point Capillary	18
Melting Point Tubes Thiele	61
Membrane Filter Holders	54
Micro Capillary Pipettes	56
Micro Litre Syringe	64
Micro Pipette	93
Micro Slide	56-57
Moisture Determination Unit	46-47
Mojjonier Flask	63
Mud Flask	10
Muffle Furnace	92

INDEX

N

Nessler Cylinder 13

O

Oil Bath 90
Oven 91-93

P

Paper Chromatography 83
Pasteur Pipette 8
Petri Dishes 23
pH Electrode, Glass 62
Pipette Bullbs 82
Pipette Filler 82
Pipette Filling Device 95
Pipetter Stand 73
Pipette 5-8,93-95
Plastic Laboratory Ware 70-75
Polenske's Apparatus 63
Police Man, Silicon Rubber 82
Powder Funnel 25
Pressure Equalizing Funnel 44-45
PTFE Laboratory Ware 70
Pyknometers 61

Q

Quartz Distillation Unit 51

R

R.B.C. Pipette 57
R.M. Value Apparatus 63
Reagent Bottles 20-21
Recovery Head 39
Rectangular Jar, Museum 24
Reichert Wollney's App. 63
Retort Rings 77
Reverse Osmosis Unit 47-51
Rotary Evaporator 84
Round Bottom Flask 27,29-30
Rubber Cork 81
Rubber Teat 82
Rubber Tubing 79-80

S

Sampling Tube (Dip Tube) 62
Schoinger Combustion Flask 62
Separating Funnels 42-44
Silica Basins/ Crucibles 65
Silicon Stoppers 82
Silicon Tubing 80
Sintered Glassware (Filtration) 52-53
Slides 56-57
Sockets 35
Soxhlet Extraction App 46
Soxhlet Extraction Unit 86
Spatulas 78,82
Specific Gravity Bottles 22
Specimen Jars 24
Splash Head 39
Stalganometer 61
Standard Joints Components 32-41
Stands (Retort, Tripod etc.) 76-78
Sterility Test Unit, SS 54
Still Head 38-39
Stirrers 41,88
Stirring Rod 61,74
Stopcocks 55
Stoppers 36,70
Stuffing Box Gland 41
Suba Seal Stoppers 81

T

Test Tube Holder 78
Test Tube Stand 73
Test Tubes 16-18
Thermometer Pocket 40
Thermometers 65,67
Thieles MP Tube 61
TLC Kit 83
Thistle Funnel 25
Tilt Measure 7
Tips 94
Tissue Homogeniser 58
Tongs 78
Tubes 14-18

U

U.V. Cabinet 83-84
Ultrasonic Cleaner 92

V

V.D.R.L. Shaker 92
V.D.R.L. Slides 57
Vacuum Oven 93
Vacuum Pumps 55
Viscometer 61
Voltmeters, Hoffman's 62
Volumetric Flask 8-10
Vortex Shaker 92

W

W.B.C. Pipette 57
Watch Glass 61
Water Baths 89-90
Water Distillations/Still 47-51
Water Softner 47-51
Water Still, SS 91
Water Taps 79
Weighing Bottles 21
Wintrobe Tubes 18
Witt's Apparatus 54
Wouff Bottles 22



LABO GLASS
Laboratory Glassware
AN ISO 9001 : 2015

A Laboratory Glassware Manufacturing Company

SCIENTIFIC GLASS CREATIONS.

4/12/2 Gandhi Nagar, Ambala Cantt-133001. Haryana-INDIA.

Phone : +91-171-269-1285 Cell : +91 999 641 6935

E-mail : info@labsglass.com , Website : www.labsglass.com